

Архангельск (8182)63-90-72
Астана (7172)727-132
Астрахань (8512)99-46-04
Барнаул (3852)73-04-60
Белгород (4722)40-23-64
Брянск (4832)59-03-52
Владивосток (423)249-28-31
Волгоград (844)278-03-48
Вологда (8172)26-41-59
Воронеж (473)204-51-73
Екатеринбург (343)384-55-89
Иваново (4932)77-34-06

Ижевск (3412)26-03-58
Иркутск (395)279-98-46
Казань (843)206-01-48
Калининград (4012)72-03-81
Калуга (4842)92-23-67
Кемерово (3842)65-04-62
Киров (8332)68-02-04
Краснодар (861)203-40-90
Красноярск (391)204-63-61
Курск (4712)77-13-04
Липецк (4742)52-20-81

Киргизия (996)312-96-26-47

Магнитогорск (3519)55-03-13
Москва (495)268-04-70
Мурманск (8152)59-64-93
Набережные Челны (8552)20-53-41
Нижний Новгород (831)429-08-12
Новокузнецк (3843)20-46-81
Новосибирск (383)227-86-73
Омск (3812)21-46-40
Орел (4862)44-53-42
Оренбург (3532)37-68-04
Пенза (8412)22-31-16

Россия (495)268-04-70

Пермь (342)205-81-47
Ростов-на-Дону (863)308-18-15
Рязань (4912)46-61-64
Самара (846)206-03-16
Санкт-Петербург (812)309-46-40
Саратов (845)249-38-78
Севастополь (8692)22-31-93
Симферополь (3652)67-13-56
Смоленск (4812)29-41-54
Сочи (862)225-72-31
Ставрополь (8652)20-65-13

Казахстан (772)734-952-31

Сургут (3462)77-98-35
Тверь (4822)63-31-35
Томск (3822)98-41-53
Тула (4872)74-02-29
Тюмень (3452)66-21-18
Ульяновск (8422)24-23-59
Уфа (347)229-48-12
Хабаровск (4212)92-98-04
Челябинск (351)202-03-61
Череповец (8202)49-02-64
Ярославль (4852)69-52-93

www.panblast.nt-rt.ru | | pav@nt-rt.ru

**Технические характеристики на
пистолеты ручные, всасывающие,
автоматические, струйные
(запчасти для дробеструйных камер)
компании PanBlast**



CS48 Gun Assembly



Product Features

The PanBlast™ CS48 Suction Blast Gun features an ergonomic handgrip for maximum operator comfort and productivity. It is ideal for use in manual suction blast cabinets.

- ▶ Economical ceramic nozzles supplied standard.
- ▶ Available in a wide range of air tip/blast nozzle combinations.
- ▶ Optional tungsten and boron carbide nozzles provide extended life.

Common Applications

- ▶ OEM blast gun replacement and/or upgrade.
- ▶ Optional on PanBlast™ Blast Cabinets.

Complementary Products



CS Blast Cabinets



PB Blast Cabinets



Delta SNH Manual Blast Gun



Delta GDF Manual Blast Gun



Delta SNH Auto Blast Gun



Delta GDF Auto Blast Gun



Godfrey Suction Gun



Omega Blast Gun

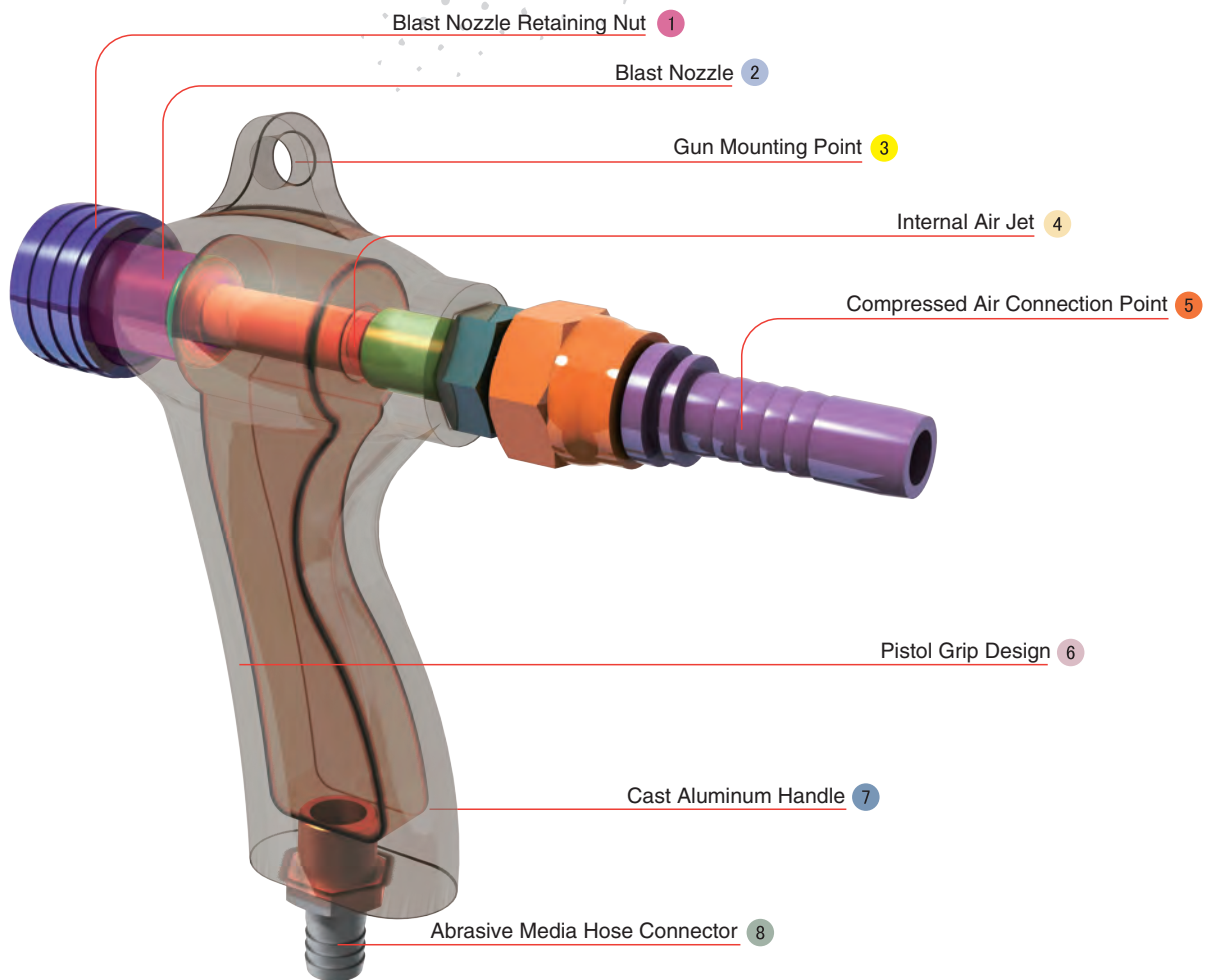
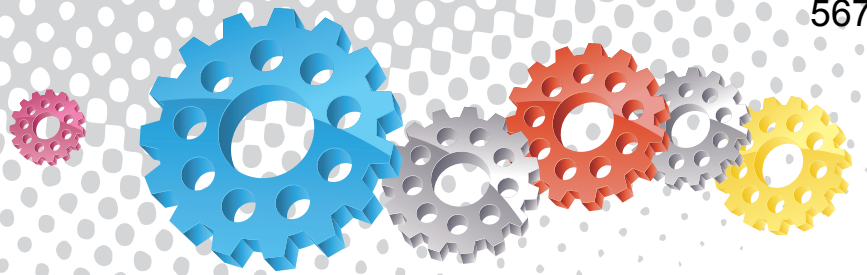

All data and information subject to change without prior notice. Brochure reference CAT-1201-07-00

Component Highlights



- 1 Blast Nozzle Retaining Nut
- 2 Blast Nozzle
- 3 Gun Mounting Point
- 4 Internal Air Jet
- 5 Compressed Air Connection Point
- 6 Pistol Grip Design
- 7 Cast Aluminum Handle
- 8 Abrasive Media Hose Connector

Assembly

Stock Code	Description	Weight
BAC-BG-0097-00	CS48 Gun Assembly with 6 mm Ceramic Nozzle	0.7 kg (1.54 lbs)



Delta GDF Manual Suction Blast Guns



Product Features

The PanBlast™ Delta GDF Manual Suction Blast Gun is highly efficient, providing maximum performance while using the least amount of compressed air possible.

- ▶ Ergonomic, lightweight design for reduced operator fatigue.
- ▶ Hardened steel air tip for longer service life.
- ▶ Aluminum jacketed, tungsten carbide nozzles.
- ▶ Mounting lug for manual gun stand attachment.
- ▶ Screw in retainer allows quick nozzle changes.
- ▶ Available in a wide range of air tip/blast nozzle combinations.
- ▶ Compatible with virtually any abrasive media type and size.

Common Applications

- ▶ Standard equipment on all PanBlast™ Suction Blast Cabinets.
- ▶ OEM suction blast gun replacement and/or upgrade.

Complementary Products



Filter Cartridge



Feed Tee & Metering Valve



Micromist Separator



CS48 Suction Gun



Foot Pedal



Delta GDF Auto Blast Gun



Delta SNH Manual Blast Gun



Delta SNH Auto Blast Gun

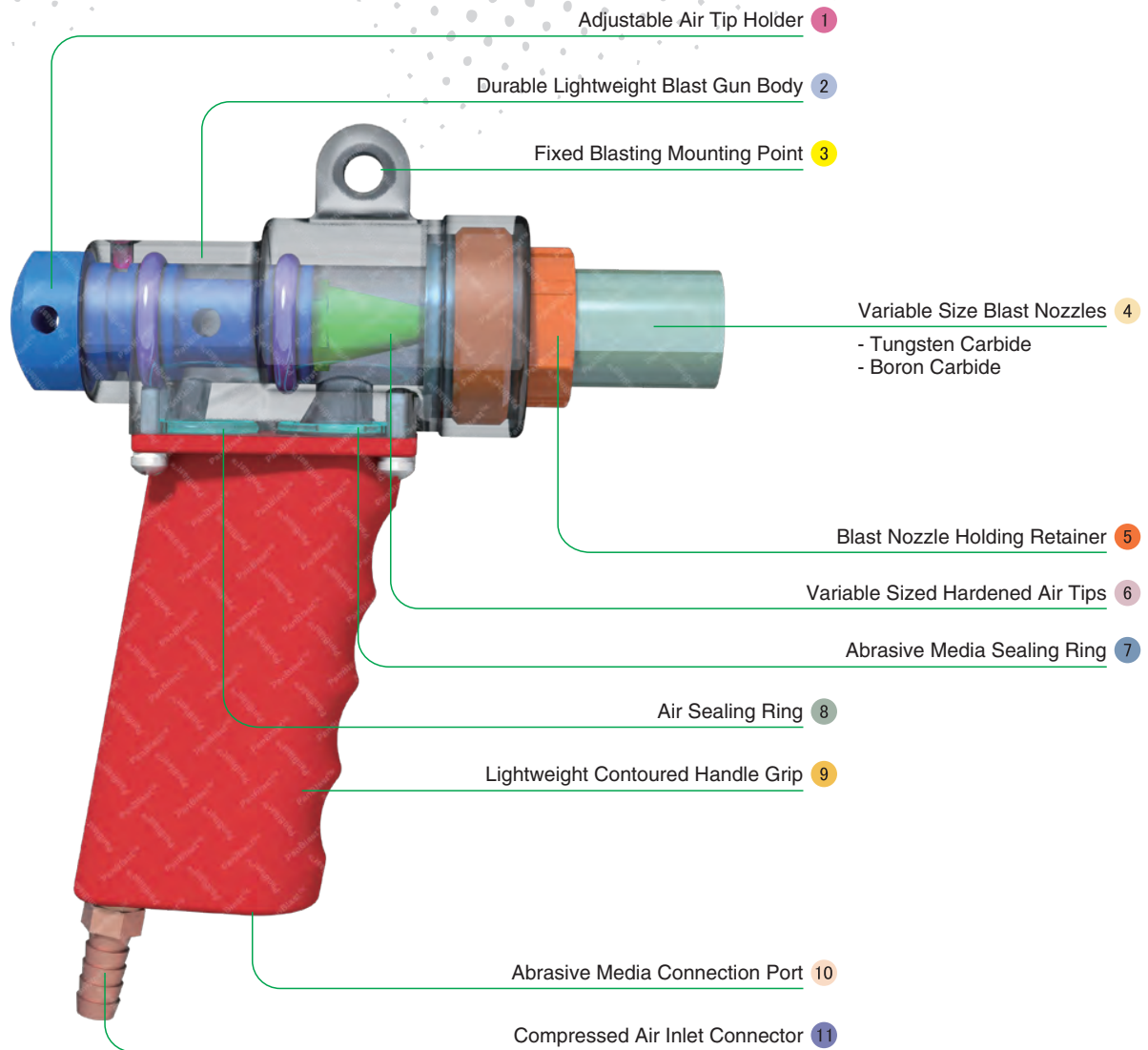

Component Highlights



- | | | |
|--------------------------------------|------------------------------------|-------------------------------------|
| 1 Adjustable Air Tip Holder | 5 Blast Nozzle Holding Retainer | 9 Lightweight Contoured Handle Grip |
| 2 Durable Lightweight Blast Gun Body | 6 Variable Sized Hardened Air Tips | 10 Abrasive Media Connection Port |
| 3 Fixed Blasting Mounting Point | 7 Abrasive Media Sealing Ring | 11 Compressed Air Inlet Connector |
| 4 Variable Size Blast Nozzles | 8 Air Sealing Ring | |

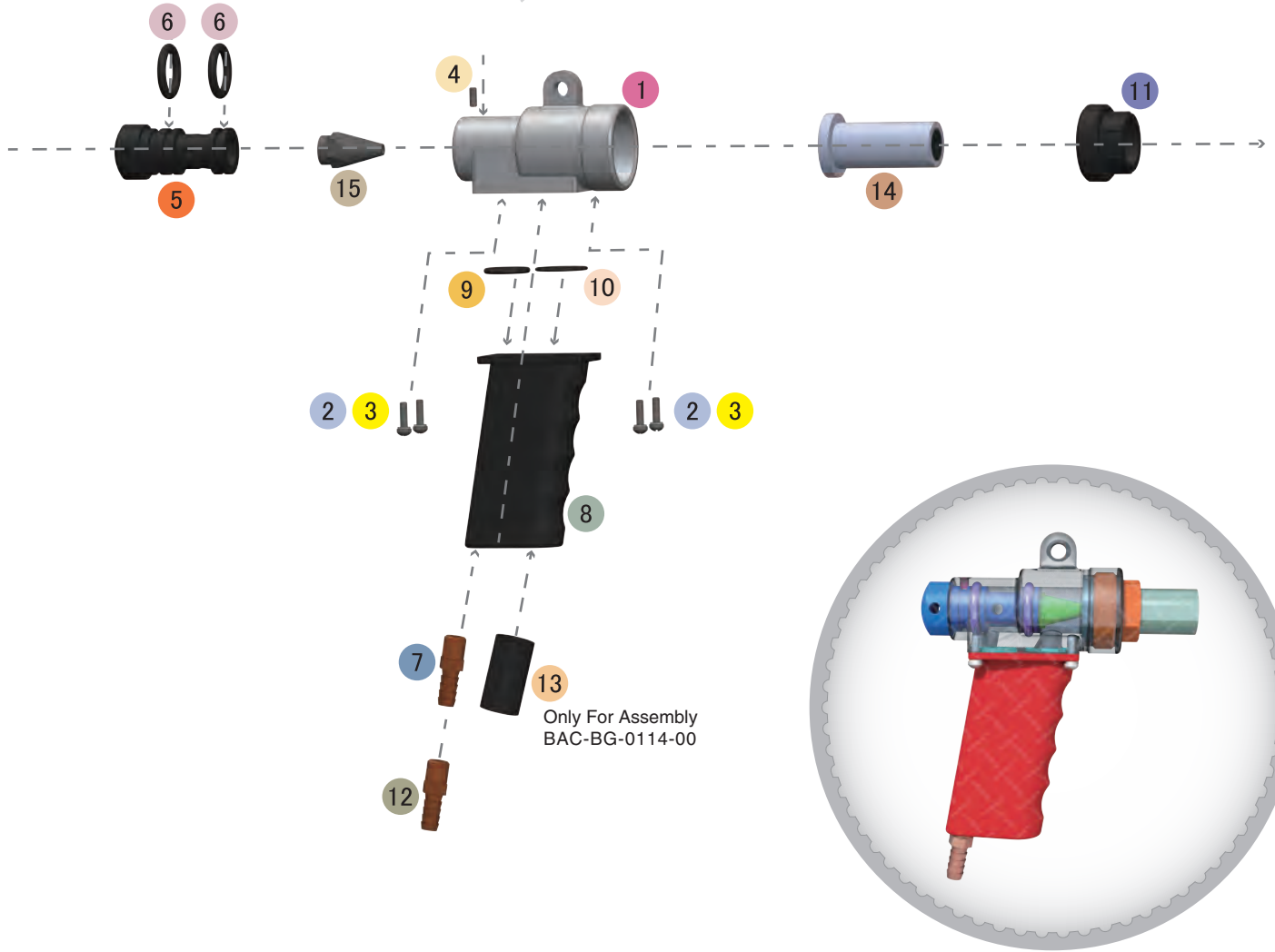
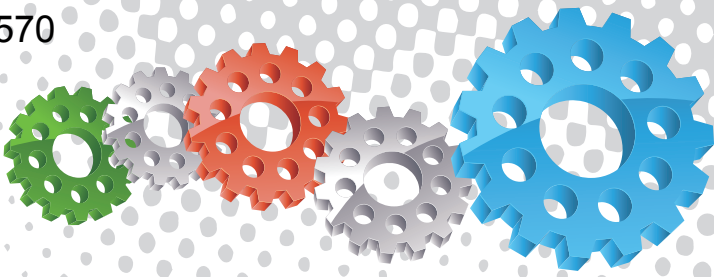

PanBlast™ Delta GDF Manual Suction Blast Guns

Stock Code	Description	Blast Nozzle		Air Tip		Compressed Air Required
		Stock Code	Size	Stock Code	Size	
BAC-BG-0114-00	Delta-M Gun CS 1/8x1/4 Tungsten Nozzle			BAC-BG-PB-0012	3.2 mm (1/8")	36 m ³ /hr (21 cfm)
BAC-BG-PB-0055	Delta-M Gun GDF 3/32x1/4 Assembly	BAC-NZ-PB-0176	6 mm (1/4")	BAC-BG-PB-0015	2.4 mm (3/32")	21 m ³ /hr (12 cfm)
BAC-BG-PB-0056	Delta-M Gun GDF 1/8x1/4 Assembly			BAC-BG-PB-0012	3.2 mm (1/8")	36 m ³ /hr (21 cfm)
BAC-BG-PB-0057	Delta-M Gun GDF 3/16x3/8 Assembly	BAC-NZ-PB-0177	10 mm (3/8")	BAC-BG-PB-0013	4.8 mm (3/16")	85 m ³ /hr (50cfm)

Parts List

Item	Stock Code	Description	Qty
1	BAC-BG-PB-0025	Gun Body	1
2	YAC-FN-PB-0121	Spring Washer	4
3	YAC-FN-PB-0234	Screw	4
4	YAC-FN-PB-0187	Screw	1
5	BAC-BG-PB-0019	Air Jet Holder	1
6	YAC-BS-PB-0008	O-ring	2
7	YAC-PF-PB-0206	Hose Barb	1
8	BAC-BG-PB-0024	Manual Gun Handle	1
9	YAC-BS-PB-0009	O-ring	1
10	YAC-BS-PB-0010	O-ring	1
11	BAC-BG-PB-0028	Nozzle Retainer	1
12	YAC-PF-PB-0122	Hose Barb	1
13	YAC-BG-0101-00	CS Gun Sleeve	1



BAC-BG-0114-00



BAC-BG-PB-0055

Blast Nozzles

Item	Stock Code	Description	Qty
14	BAC-NZ-PB-0175	Blast Nozzle Godfrey 1/8" Tungsten	1
	BAC-NZ-PB-0179	Blast Nozzle Godfrey 3/16" Tungsten	1
	BAC-NZ-PB-0176	Blast Nozzle Godfrey 1/4" Tungsten	1
	BAC-NZ-PB-0227	Blast Nozzle Godfrey 5/16" Tungsten	1
	BAC-NZ-PB-0177	Blast Nozzle Godfrey 3/8" Tungsten	1
	BAC-NZ-PB-0178	Blast Nozzle Godfrey 1/2" Tungsten	1
	BAC-NZ-PB-0236	Blast Nozzle Godfrey 9/16" Tungsten	1



BAC-BG-PB-0056

Air Tips

Item	Stock Code	Description	Qty
15	BAC-BG-PB-0011	1.6 mm (1/16") Air Jet	1
	BAC-BG-PB-0015	2.4 mm (3/32") Air Jet	1
	BAC-BG-PB-0012	3.2 mm (1/8") Air Jet	1
	BAC-BG-PB-0013	4.8 mm (3/16") Air Jet	1
	BAC-BG-PB-0014	6 mm (1/4") Air Jet	1



BAC-BG-PB-0057



Delta GDF Auto Suction Blast Guns



Product Features

The PanBlast™ Delta GDF Auto Suction Blast Gun is designed specifically for use on automated suction blasting machines.

- ▶ Ergonomic, lightweight design for more efficient mounting and manipulation.
- ▶ Case hardened steel air tip for longer service life.
- ▶ Aluminum jacketed, tungsten carbide blast nozzles.
- ▶ Mounting lug for quick attachment to bracket and/or manipulator.
- ▶ Screw in retainer for quick nozzle changes.
- ▶ Available in a wide range of air tip/blast nozzle combinations.
- ▶ Compatible with virtually any abrasive media type and size.
- ▶ Optional hardened heavy duty air tip available.

Common Applications

- ▶ Automated suction blasting operations.
- ▶ OEM blast gun replacement and/or upgrade.

Complementary Products



Filter Cartridge



Feed Tee & Metering Valve



Micromist Separator



CS48 Suction Gun



Delta GDF Manual Blast Gun



Foot Pedal



Delta SNH Manual Blast Gun



Delta SNH Auto Blast Gun

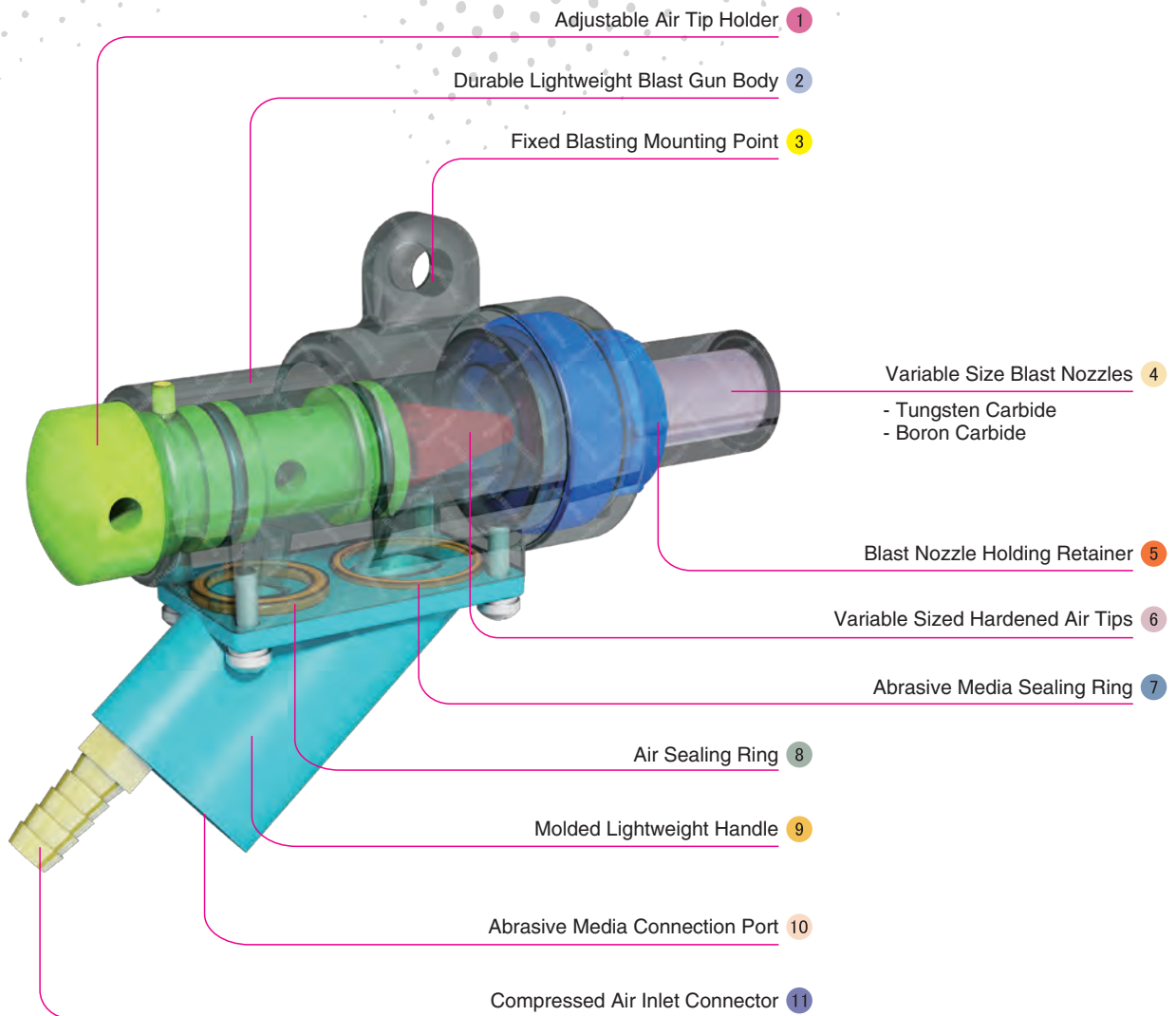

Component Highlights



- | | | |
|--------------------------------------|------------------------------------|-----------------------------------|
| 1 Adjustable Air Tip Holder | 5 Blast Nozzle Holding Retainer | 9 Molded Lightweight Handle |
| 2 Durable Lightweight Blast Gun Body | 6 Variable Sized Hardened Air Tips | 10 Abrasive Media Connection Port |
| 3 Fixed Blasting Mounting Point | 7 Abrasive Media Sealing Ring | 11 Compressed Air Inlet Connector |
| 4 Variable Size Blast Nozzles | 8 Air Sealing Ring | |

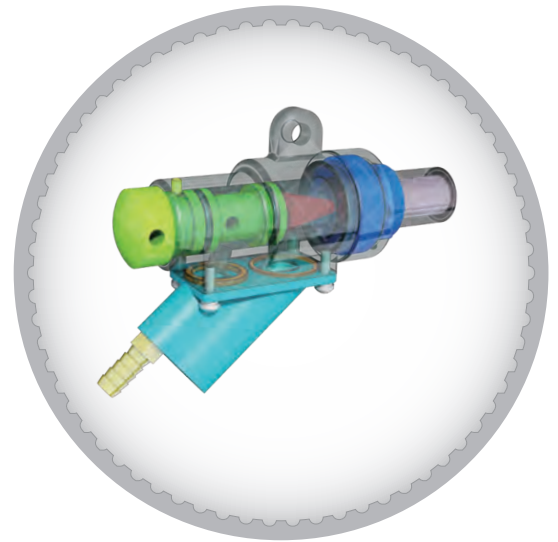
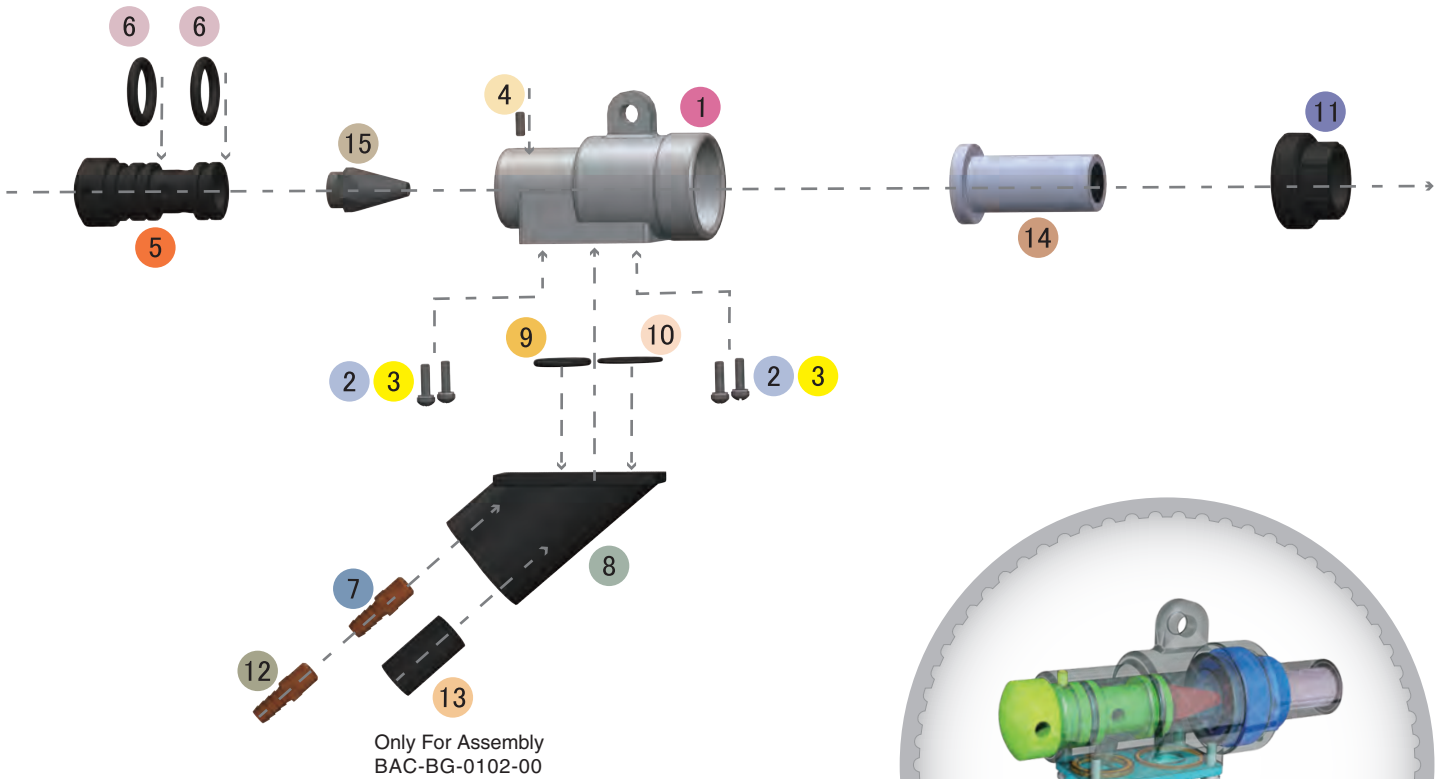
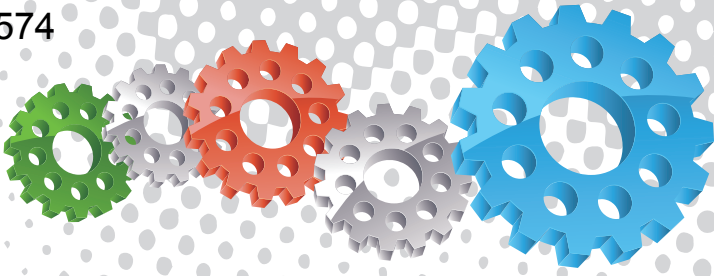

PanBlast™ Delta GDF Auto Suction Blast Guns

Stock Code	Description	Blast Nozzle		Air Tip		Compressed Air Required
		Stock Code	Size	Stock Code	Size	
BAC-BG-0102-00	Delta-A Gun CS 1/8x1/4 Tungsten Nozzle			BAC-BG-PB-0012	3.2 mm (1/8")	36 m ³ /hr (21 cfm)
BAC-BG-PB-0061	Delta-A Gun GDF 3/32x1/4 Assembly	BAC-NZ-PB-0176	6 mm (1/4")	BAC-BG-PB-0015	2.4 mm (3/32")	21 m ³ /hr (12 cfm)
BAC-BG-PB-0062	Delta-A Gun GDF 1/8x1/4 Assembly			BAC-BG-PB-0012	3.2 mm (1/8")	36 m ³ /hr (21 cfm)
BAC-BG-PB-0063	Delta-A Gun GDF 3/16x3/8 Assembly	BAC-NZ-PB-0177	10 mm (3/8")	BAC-BG-PB-0013	4.8 mm (3/16")	85 m ³ /hr (50 cfm)

Parts List

Item	Stock Code	Description	Qty
1	BAC-BG-PB-0025	Gun Body	1
2	YAC-FN-PB-0121	Spring Washer	4
3	YAC-FN-PB-0234	Screw	4
4	YAC-FN-PB-0187	Screw	1
5	BAC-BG-PB-0019	Air Jet Holder	1
6	YAC-BS-PB-0008	O-ring	2
7	YAC-PF-PB-0206	Hose Barb	1
8	BAC-BG-PB-0023	Auto Gun Handle	1
9	YAC-BS-PB-0009	O-ring	1
10	YAC-BS-PB-0010	O-ring	1
11	BAC-BG-PB-0028	Nozzle Retainer	1
12	YAC-PF-PB-0122	Hose Barb	1
13	YAC-BG-0101-00	CS Gun Sleeve	1



BAC-BG-0102-00

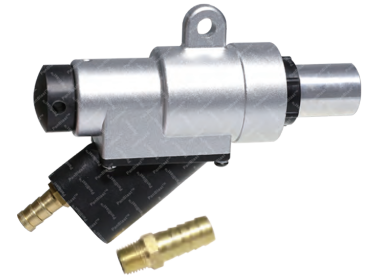

BAC-BG-PB-0061

Blast Nozzles

Item	Stock Code	Description	Qty
14	BAC-NZ-PB-0175	Blast Nozzle Godfrey 1/8" Tungsten	1
	BAC-NZ-PB-0179	Blast Nozzle Godfrey 3/16" Tungsten	1
	BAC-NZ-PB-0176	Blast Nozzle Godfrey 1/4" Tungsten	1
	BAC-NZ-PB-0227	Blast Nozzle Godfrey 5/16" Tungsten	1
	BAC-NZ-PB-0177	Blast Nozzle Godfrey 3/8" Tungsten	1
	BAC-NZ-PB-0178	Blast Nozzle Godfrey 1/2" Tungsten	1
	BAC-NZ-PB-0236	Blast Nozzle Godfrey 9/16" Tungsten	1

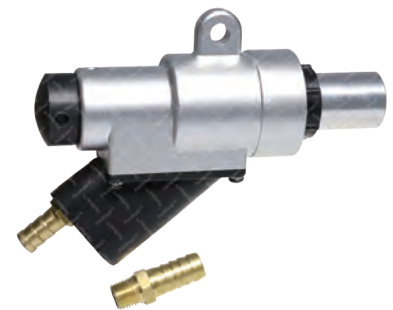

BAC-BG-PB-0062

Air Tips

Item	Stock Code	Description	Qty
15	BAC-BG-PB-0011	1.6 mm (1/16") Air Jet	1
	BAC-BG-PB-0015	2.4 mm (3/32") Air Jet	1
	BAC-BG-PB-0012	3.2 mm (1/8") Air Jet	1
	BAC-BG-PB-0013	4.8 mm (3/16") Air Jet	1
	BAC-BG-PB-0014	6 mm (1/4") Air Jet	1



BAC-BG-PB-0063



Delta SNH Manual Suction Blast Guns



Product Features

The PanBlast™ Delta SNH Suction Blast Gun is highly efficient, providing maximum performance while using the least amount of compressed air possible.

- ▶ Ergonomic, lightweight design for reduced operator fatigue.
- ▶ Hardened steel air tip for longer service life.
- ▶ Available with either boron carbide or ceramic blast nozzle.
- ▶ Mounting lug for gun stand attachment.
- ▶ Screw in retainer allows quick nozzle changes.
- ▶ Available in a wide range of air tip/blast nozzle combinations.
- ▶ Compatible with virtually any abrasive media type and size.

Common Applications

- ▶ Standard equipment on all PanBlast™ Suction Blast Cabinets.
- ▶ OEM suction blast gun replacement and/or upgrade.

Complementary Products



Filter Cartridge



Micromist Separator



Foot Pedal



Delta GDF Manual Blast Gun



Feed Tee & Metering Valve



CS48 Suction Gun



Delta GDF Auto Blast Gun



Delta SNH Auto Blast Gun

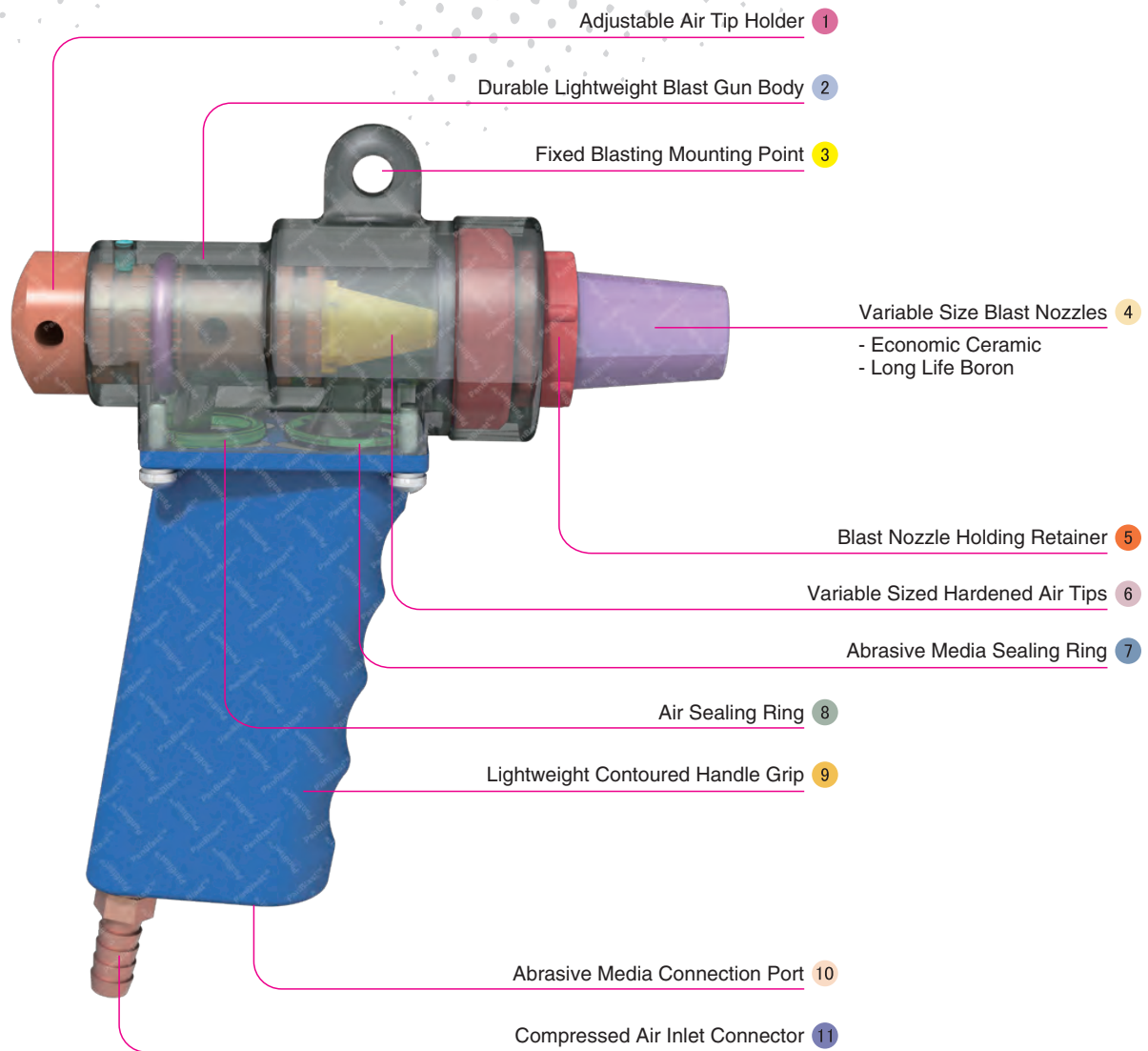

Component Highlights



- | | | |
|--------------------------------------|------------------------------------|-------------------------------------|
| 1 Adjustable Air Tip Holder | 5 Blast Nozzle Holding Retainer | 9 Lightweight Contoured Handle Grip |
| 2 Durable Lightweight Blast Gun Body | 6 Variable Sized Hardened Air Tips | 10 Abrasive Media Connection Port |
| 3 Fixed Blasting Mounting Point | 7 Abrasive Media Sealing Ring | 11 Compressed Air Inlet Connector |
| 4 Variable Size Blast Nozzles | 8 Air Sealing Ring | |

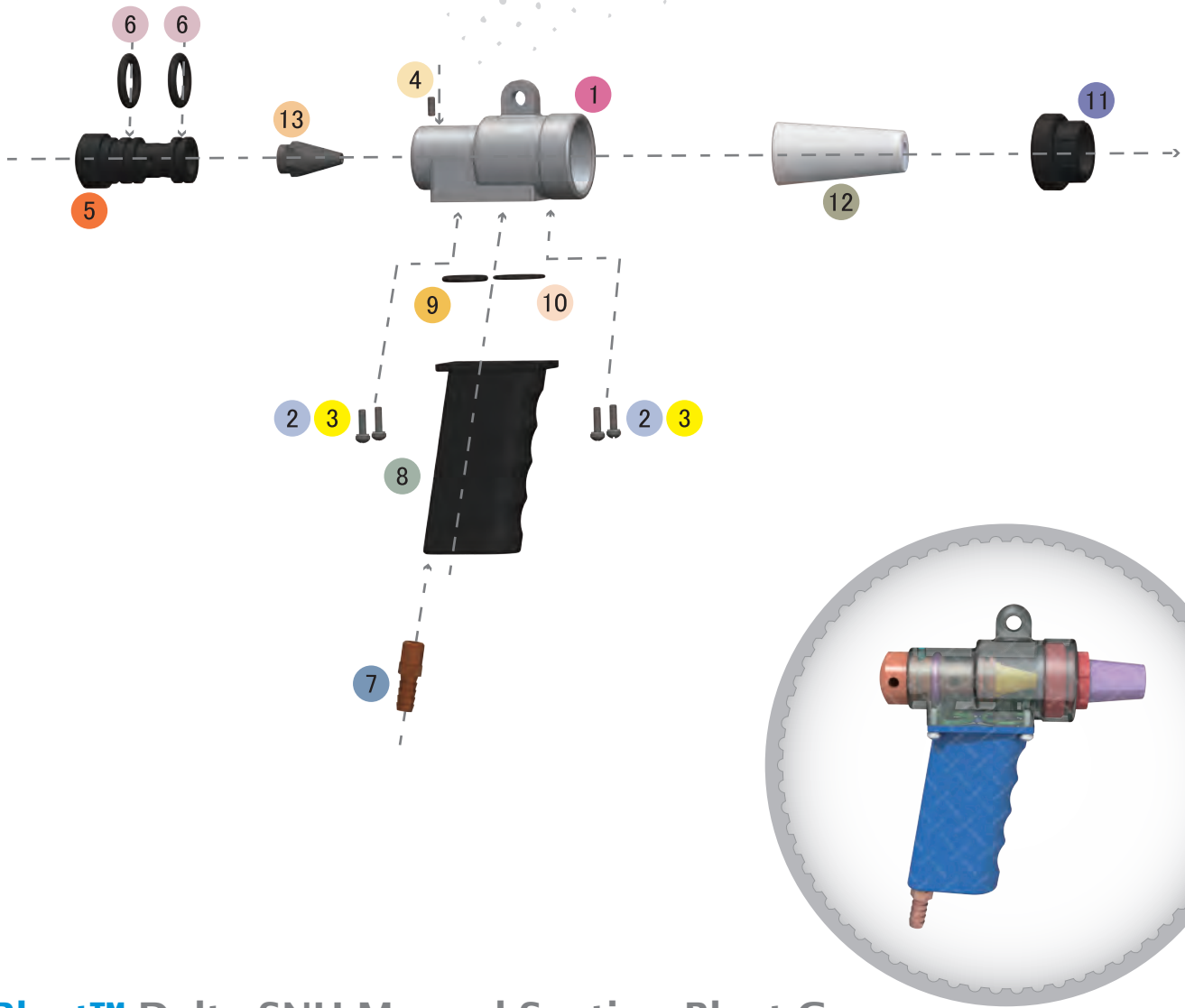
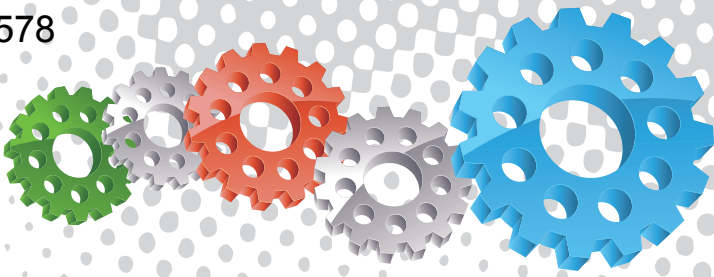

PanBlast™ Delta SNH Manual Suction Blast Guns

Stock Code	Description	Blast Nozzle		Air Tip		Compressed Air Required
		Stock Code	Size	Stock Code	Size	
BAC-BG-PB-0052	Delta-M Gun SNH 3/32x3/16 Assembly	BAC-NZ-PB-0319	5 mm (3/16")	BAC-BG-PB-0015	2.4 mm (3/32")	21 m ³ /hr (12 cfm)
BAC-BG-PB-0053	Delta-M Gun SNH 1/8x1/4 Assembly	BAC-NZ-PB-0321	6 mm (1/4")	BAC-BG-PB-0012	3.2 mm (1/8")	36 m ³ /hr (21 cfm)
BAC-BG-PB-0054	Delta-M Gun SNH 3/16x11/32 Assembly	BAC-NZ-PB-0325	9 mm (11/32")	BAC-BG-PB-0013	4.8 mm (3/16")	85 m ³ /hr (50 cfm)
BAC-BG-0105-00	Delta-M Suction Blast Gun/5mm Boron Noz	BAC-NZ-PB-0267	5 mm (3/16")	BAC-BG-PB-0015	2.4 mm (3/32")	21 m ³ /hr (12 cfm)
BAC-BG-0106-00	Delta-M Suction Blast Gun/6mm Boron Noz	BAC-NZ-PB-0264	6 mm (1/4")	BAC-BG-PB-0012	3.2 mm (1/8")	36 m ³ /hr (21 cfm)
BAC-BG-0111-00	Delta-M Suction Blast Gun/8mm Boron Noz	BAC-NZ-PB-0268	8 mm (5/16")	BAC-BG-PB-0012	3.2 mm (1/8")	69 m ³ /hr (41 cfm)
BAC-BG-0107-00	Delta-M Suction Blast Gun/9mm Boron Noz	BAC-NZ-PB-0265	9 mm (11/32")	BAC-BG-PB-0013	4.8 mm (3/16")	85 m ³ /hr (50 cfm)

Parts List

Item	Stock Code	Description	Qty
1	BAC-BG-PB-0025	Delta Gun Body	1
2	YAC-FN-PB-0121	Spring Washer	4
3	YAC-FN-PB-0234	Screw	4
4	YAC-FN-PB-0187	Screw	1
5	BAC-BG-PB-0019	GF Air Jet Holder	1
6	YAC-BS-PB-0008	O-ring	2
7	YAC-PF-PB-0206	Hose Barb	1
8	BAC-BG-PB-0024	Delta Manual Gun Handle	1
9	YAC-BS-PB-0009	O-ring	1
10	YAC-BS-PB-0010	O-ring	1
11	BAC-BG-PB-0043	Delta SNH Gun Nozzle Retainer	1



BAC-BG-0105-00



BAC-BG-PB-0052



BAC-BG-0106-00



BAC-BG-PB-0053



BAC-BG-0111-00



BAC-BG-PB-0054



BAC-BG-0107-00

Blast Nozzles

Item	Stock Code	Description	Qty
12	BAC-NZ-PB-0319	SNH CSN Ceramic Blast Nozzle - 5 mm	1
	BAC-NZ-PB-0321	SNH CSN Ceramic Blast Nozzle - 6 mm	1
	BAC-NZ-PB-0323	SNH CSN Ceramic Blast Nozzle - 8 mm	1
	BAC-NZ-PB-0325	SNH CSN Ceramic Blast Nozzle - 9 mm	1
	BAC-NZ-PB-0263	SNH BSN Boron Blast Nozzle - 3 mm	1
	BAC-NZ-PB-0266	SNH BSN Boron Blast Nozzle - 4 mm	1
	BAC-NZ-PB-0267	SNH BSN Boron Blast Nozzle - 5 mm	1
	BAC-NZ-PB-0264	SNH BSN Boron Blast Nozzle - 6 mm	1
	BAC-NZ-PB-0269	SNH BSN Boron Blast Nozzle - 7 mm	1
	BAC-NZ-PB-0268	SNH BSN Boron Blast Nozzle - 8 mm	1
	BAC-NZ-PB-0265	SNH BSN Boron Blast Nozzle - 9 mm	1

Air Tips

Item	Stock Code	Description	Qty
13	BAC-BG-PB-0011	1.6 mm (1/16") Air Jet	1
	BAC-BG-PB-0015	2.4 mm (3/32") Air Jet	1
	BAC-BG-PB-0012	3.2 mm (1/8") Air Jet	1
	BAC-BG-PB-0013	4.8 mm (3/16") Air Jet	1
	BAC-BG-PB-0014	6 mm (1/4") Air Jet	1



Delta SNH Auto Suction Blast Guns



Complementary Products



Filter Cartridge



Micromist Separator



Foot Pedal



Delta GDF Manual Blast Gun



Feed Tee & Metering Valve



CS48 Suction Gun



Delta GDF Auto Blast Gun



Delta SNH Manual Blast Gun



Product Features

The PanBlast™ Delta Auto Suction Blast Gun is designed specifically for use on automated suction blasting machines.

- ▶ Ergonomic, lightweight design for more efficient mounting and manipulation.
- ▶ Case hardened steel air tip for longer service life.
- ▶ Optional hardened heavy duty air tip available.
- ▶ Available with either boron carbide or ceramic blast nozzles.
- ▶ Mounting lug for quick, simple attachment to bracket and/or manipulator.
- ▶ Screw in retainer for quick nozzle changes.
- ▶ Available in a wide range of air tip/blast nozzle combinations.
- ▶ Compatible with virtually any abrasive media type and size.

Common Applications

- ▶ Automated suction blasting operations.
- ▶ OEM blast gun replacement and/or upgrade.

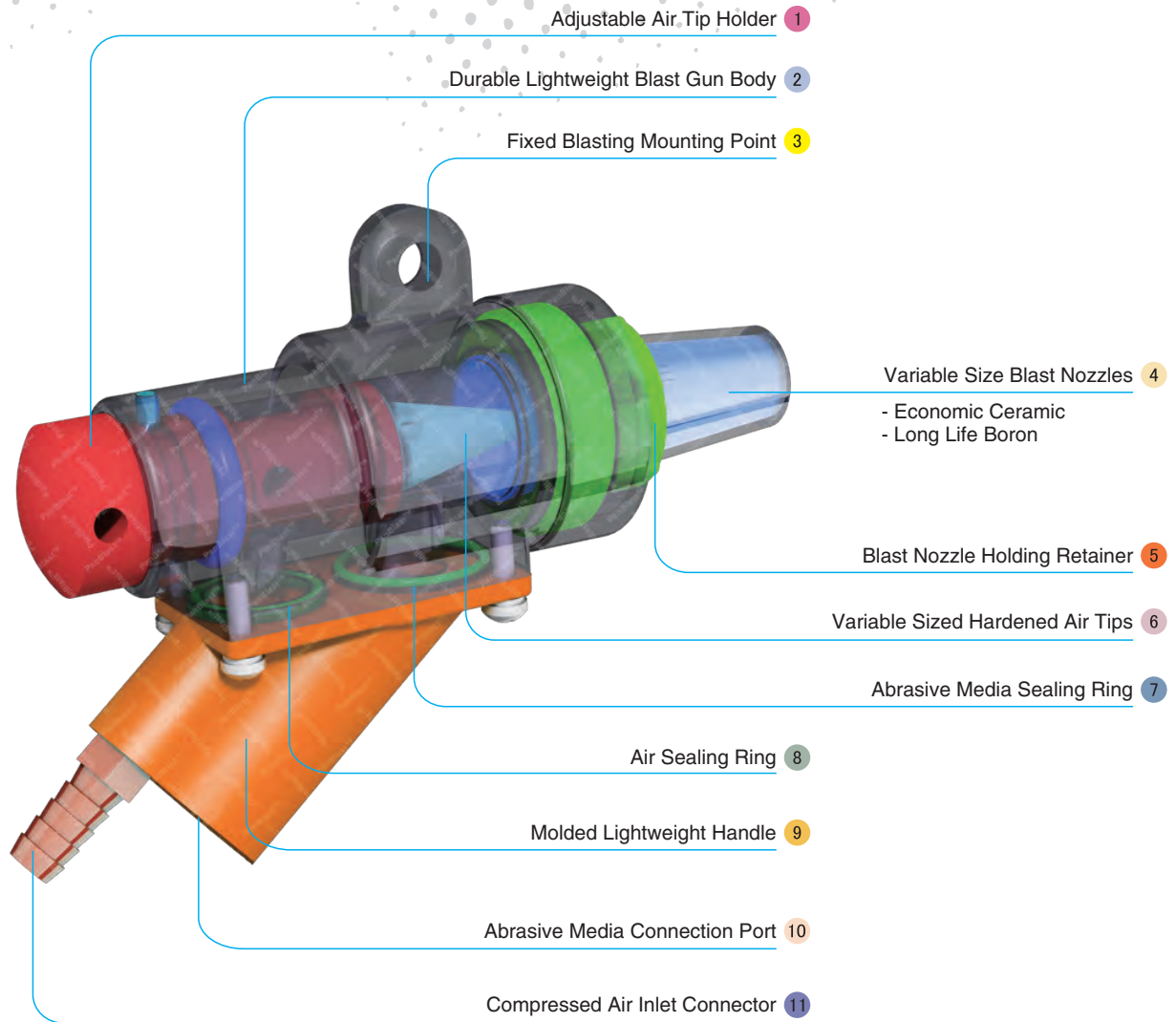

Component Highlights



- | | | |
|--------------------------------------|------------------------------------|-----------------------------------|
| 1 Adjustable Air Tip Holder | 5 Blast Nozzle Holding Retainer | 9 Molded Lightweight Handle |
| 2 Durable Lightweight Blast Gun Body | 6 Variable Sized Hardened Air Tips | 10 Abrasive Media Connection Port |
| 3 Fixed Blasting Mounting Point | 7 Abrasive Media Sealing Ring | 11 Compressed Air Inlet Connector |
| 4 Variable Size Blast Nozzles | 8 Air Sealing Ring | |

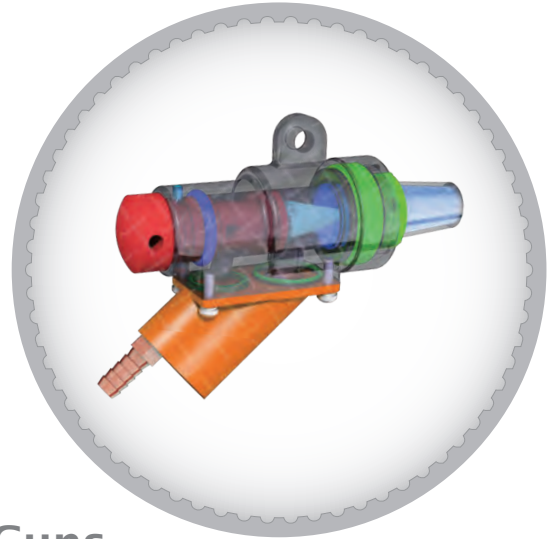
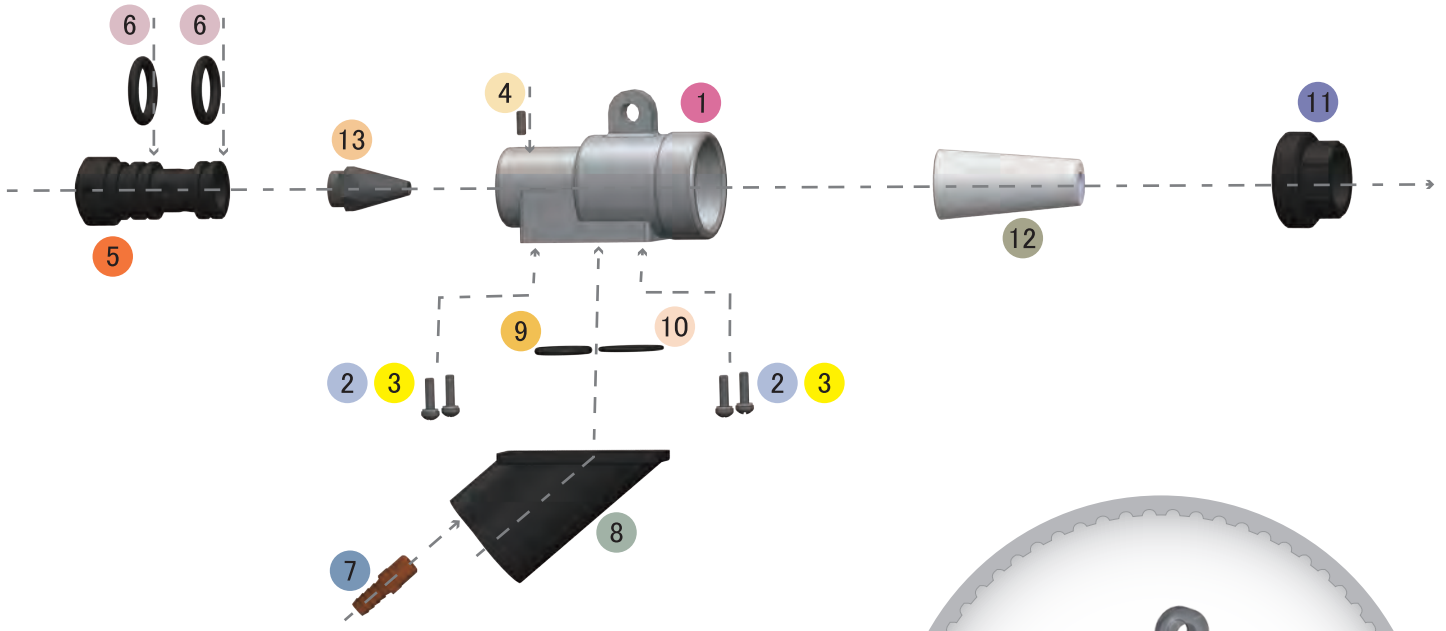
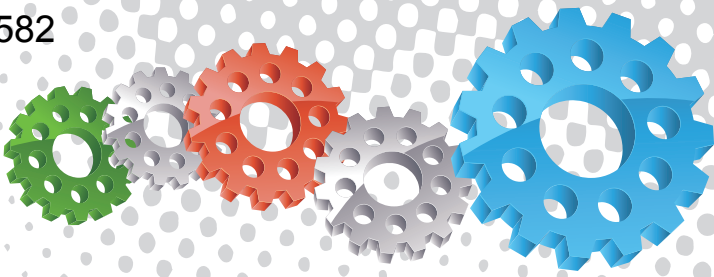

PanBlast™ Delta SNH Auto Suction Blast Guns

Stock Code	Description	Blast Nozzle		Air Tip		Compressed Air Required
		Stock Code	Size	Stock Code	Size	
BAC-BG-PB-0058	Delta-A Gun SNH 3/32x1/4 Assembly	BAC-NZ-PB-0321	6 mm (1/4")	BAC-BG-PB-0015	2.4 mm (3/32")	21 m ³ /hr (12 cfm)
BAC-BG-PB-0059	Delta-A Gun SNH 1/8x1/4 Assembly	BAC-NZ-PB-0321	6 mm (1/4")	BAC-BG-PB-0012	3.2 mm (1/8")	36 m ³ /hr (21 cfm)
BAC-BG-PB-0060	Delta-A Gun SNH 3/16x11/32 Assembly	BAC-NZ-PB-0325	9 mm (11/32")	BAC-BG-PB-0013	4.8 mm (3/16")	85 m ³ /hr (50 cfm)
BAC-BG-0108-00	Delta-A Suction Blast Gun/5 mm Boron Noz	BAC-NZ-PB-0267	5 mm (3/16")	BAC-BG-PB-0015	2.4 mm (3/32")	21 m ³ /hr (12 cfm)
BAC-BG-0109-00	Delta-A Suction Blast Gun/6 mm Boron Noz	BAC-NZ-PB-0264	6 mm (1/4")	BAC-BG-PB-0012	3.2 mm (1/8")	36 m ³ /hr (21 cfm)
BAC-BG-0112-00	Delta-A Suction Blast Gun/8 mm Boron Noz	BAC-NZ-PB-0268	8 mm (5/16")	BAC-BG-PB-0012	3.2 mm (1/8")	69 m ³ /hr (41 cfm)
BAC-BG-0110-00	Delta-A Suction Blast Gun/9 mm Boron Noz	BAC-NZ-PB-0265	9 mm (11/32")	BAC-BG-PB-0013	4.8 mm (3/16")	85 m ³ /hr (50 cfm)

Parts List

Item	Stock Code	Description	Qty
1	BAC-BG-PB-0025	Delta Gun Body	1
2	YAC-FN-PB-0121	Spring Washer	4
3	YAC-FN-PB-0234	Screw	4
4	YAC-FN-PB-0187	Screw	1
5	BAC-BG-PB-0019	GF Air Jet Holder	1
6	YAC-BS-PB-0008	O-ring	2
7	YAC-PF-PB-0206	Hose Barb	1
8	BAC-BG-PB-0023	Delta Auto Gun Handle	1
9	YAC-BS-PB-0009	O-ring	1
10	YAC-BS-PB-0010	O-ring	1
11	BAC-BG-PB-0043	Delta SNH Gun Nozzle Retainer	1



BAC-BG-0108-00



BAC-BG-PB-0058



BAC-BG-0109-00

Blast Nozzles

Item	Stock Code	Description	Qty
12	BAC-NZ-PB-0319	SNH CSN Ceramic Blast Nozzle - 5 mm	1
	BAC-NZ-PB-0321	SNH CSN Ceramic Blast Nozzle - 6 mm	1
	BAC-NZ-PB-0323	SNH CSN Ceramic Blast Nozzle - 8 mm	1
	BAC-NZ-PB-0325	SNH CSN Ceramic Blast Nozzle - 9 mm	1
	BAC-NZ-PB-0263	SNH BSN Boron Blast Nozzle - 3 mm	1
	BAC-NZ-PB-0266	SNH BSN Boron Blast Nozzle - 4 mm	1
	BAC-NZ-PB-0267	SNH BSN Boron Blast Nozzle - 5 mm	1
	BAC-NZ-PB-0264	SNH BSN Boron Blast Nozzle - 6 mm	1
	BAC-NZ-PB-0269	SNH BSN Boron Blast Nozzle - 7 mm	1
	BAC-NZ-PB-0268	SNH BSN Boron Blast Nozzle - 8 mm	1
	BAC-NZ-PB-0265	SNH BSN Boron Blast Nozzle - 9 mm	1



BAC-BG-PB-0059



BAC-BG-0112-00



BAC-BG-PB-0060

Air Tips

Item	Stock Code	Description	Qty
13	BAC-BG-PB-0011	1.6 mm (1/16") Air Jet	1
	BAC-BG-PB-0015	2.4 mm (3/32") Air Jet	1
	BAC-BG-PB-0012	3.2 mm (1/8") Air Jet	1
	BAC-BG-PB-0013	4.8 mm (3/16") Air Jet	1
	BAC-BG-PB-0014	6 mm (1/4") Air Jet	1



BAC-BG-0110-00



Godfrey Suction Blast Guns

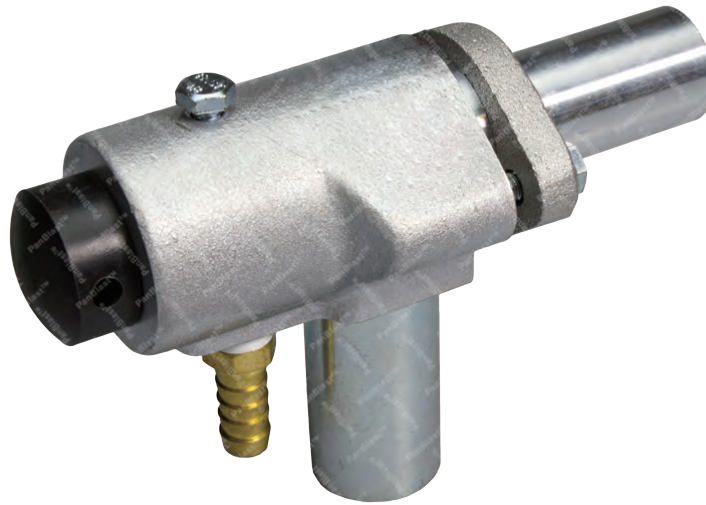

Product Features

The PanBlast™ Godfrey Suction Blast Gun is a highly efficient, manually operated design, providing maximum performance with the least amount of compressed air possible.

- ▶ Durable, aluminum jacketed, tungsten carbide nozzles.
- ▶ Available in a wide range of air tip/blast nozzle combinations.

Complementary Products



Filter Cartridge



Cabinet Window Cover



Blast Cabinets



Pow Air Vac



Delta SNH Auto Blast Gun



Delta GDF Auto Blast Gun



Delta SNH Manual Blast Gun



Delta GDF Manual Blast Gun

Common Applications

- ▶ Optional on PanBlast™ Blast Cabinets.
- ▶ OEM blast gun replacement and/or upgrade.

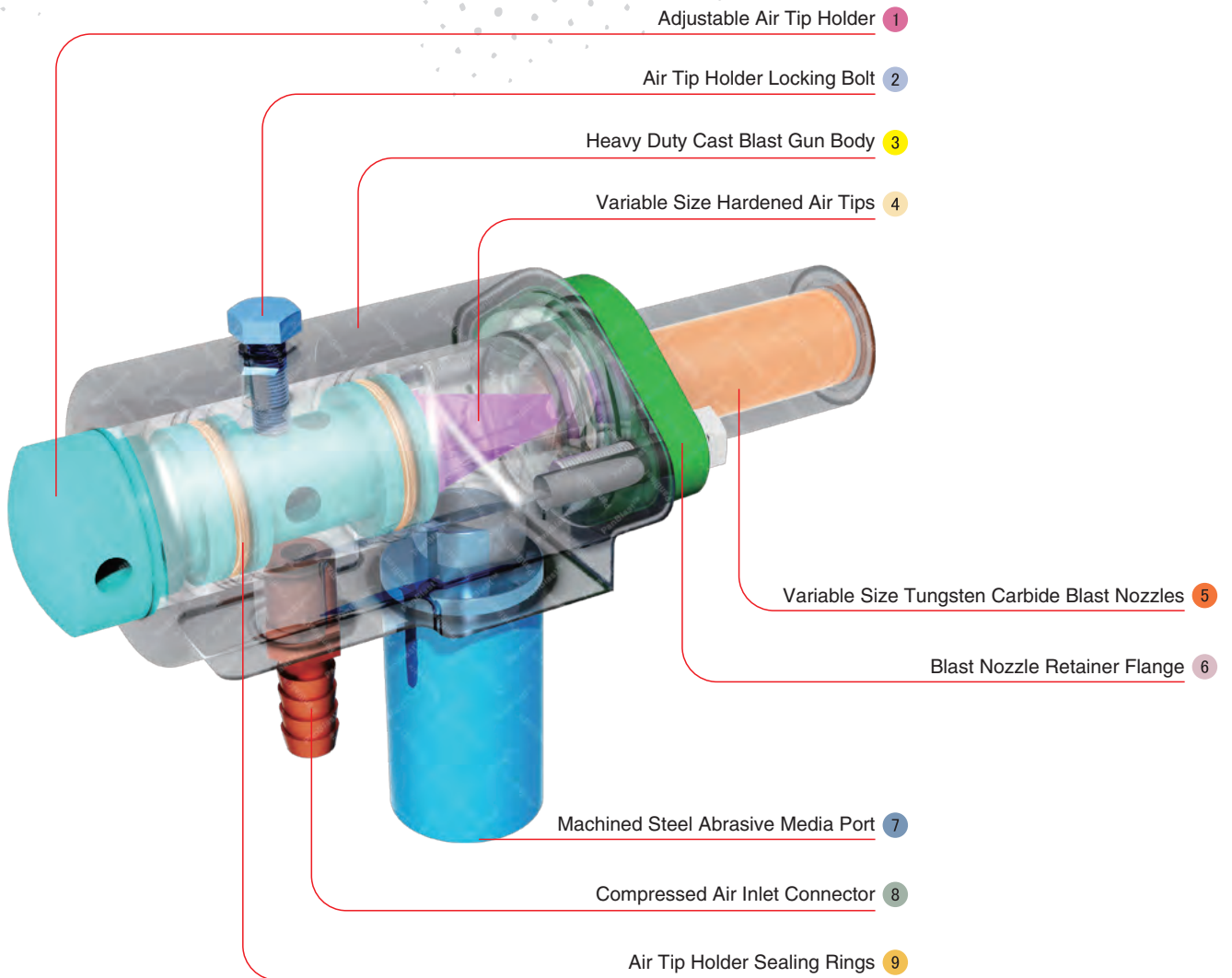

Component Highlights



- | | | |
|----------------------------------|--|--------------------------------------|
| 1 Adjustable Air Tip Holder | 4 Variable Size Hardened Air Tips | 7 Machined Steel Abrasive Media Port |
| 2 Air Tip Holder Locking Bolt | 5 Variable Size Tungsten Carbide Blast Nozzles | 8 Compressed Air Inlet Connector |
| 3 Heavy Duty Cast Blast Gun Body | 6 Blast Nozzle Retainer Flange | 9 Air Tip Holder Sealing Rings |

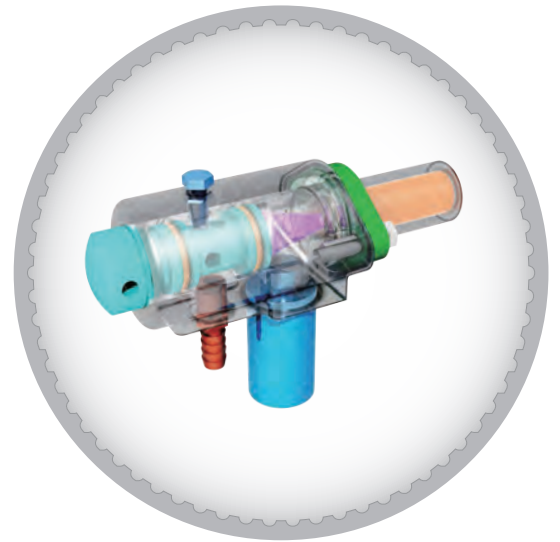
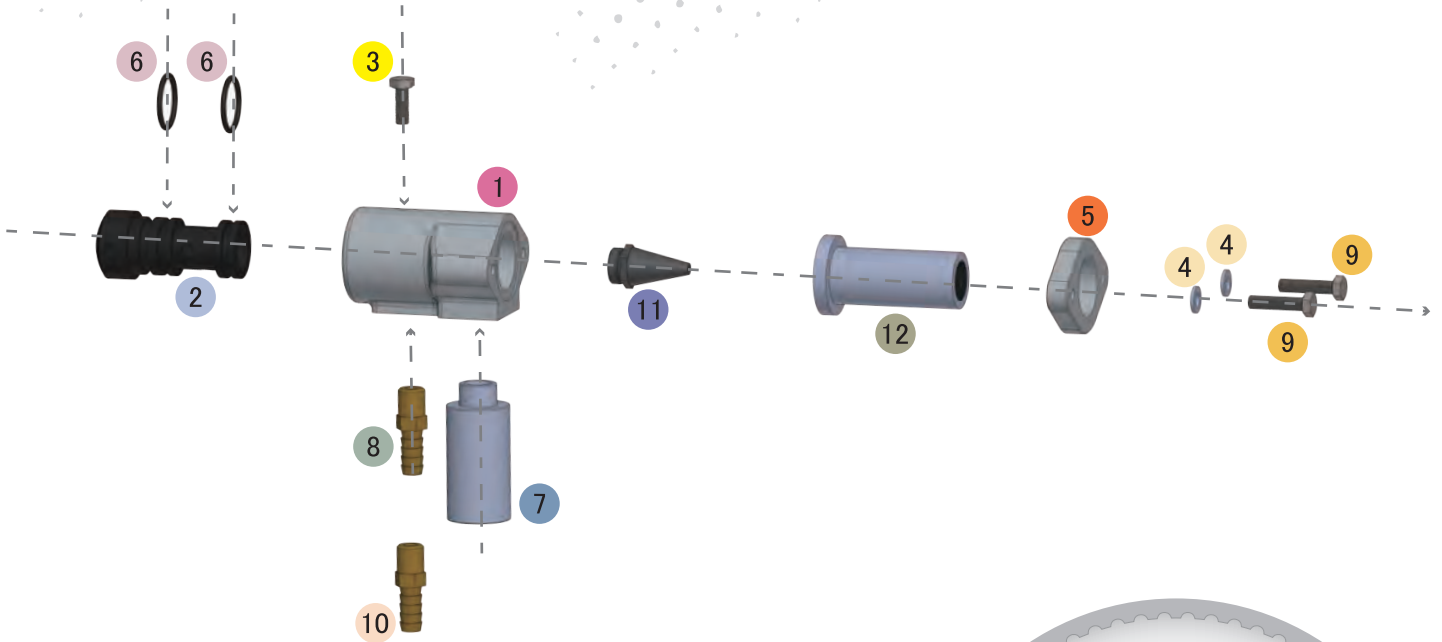
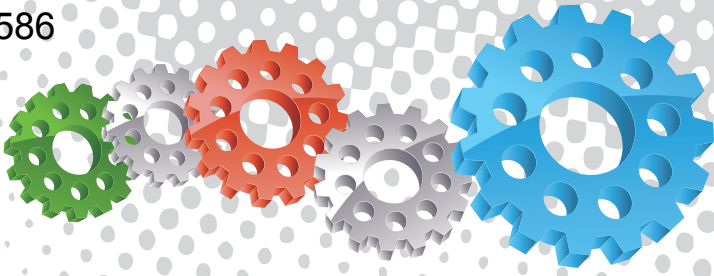

PanBlast™ Godfrey Suction Blast Guns

Stock Code	Description	Blast Nozzle		Air Tip		Compressed Air Required
		Stock Code	Size	Stock Code	Size	
BAC-BG-PB-0002	Godfrey Suction Gun 3/32x3/16 Assembly	BAC-NZ-PB-0179	4.8 mm (3/16")	BAC-BG-PB-0015	2.4 mm (3/32")	21 m ³ /hr (12 cfm)
BAC-BG-PB-0003	Godfrey Suction Gun 1/16x3/16 Assembly	BAC-NZ-PB-0179	4.8 mm (3/16")	BAC-BG-PB-0011	1.6 mm (1/16")	9 m ³ /hr (5.2 cfm)
BAC-BG-PB-0004	Godfrey Suction Gun 1/8x1/4 Assembly	BAC-NZ-PB-0176	6 mm (1/4")	BAC-BG-PB-0012	3.2 mm (1/8")	36 m ³ /hr (21 cfm)
BAC-BG-PB-0005	Godfrey Suction Gun 3/16x3/8 Assembly	BAC-NZ-PB-0177	10 mm (3/8")	BAC-BG-PB-0013	4.8 mm (3/16")	85 m ³ /hr (50 cfm)
BAC-BG-PB-0006	Godfrey Suction Gun 1/4x1/2 Assembly	BAC-NZ-PB-0178	12.7 mm (1/2")	BAC-BG-PB-0014	6 mm (1/4")	144 m ³ /hr (84 cfm)
BAC-BG-PB-0007	Godfrey Suction Gun 1/8x3/8 Assembly	BAC-NZ-PB-0177	10 mm (3/8")	BAC-BG-PB-0012	3.2 mm (1/8")	36 m ³ /hr (21 cfm)

Parts List

Item	Stock Code	Description	Qty
1	BAC-BG-PB-0016	GF Suction Blast Gun Body	1
2	BAC-BG-PB-0019	GF Air Jet Holder	1
3	YAC-FN-PB-0040	Screw	1
4	YAC-FN-PB-0007	Flat Washer	2
5	YAC-BG-PB-0020	Gun Nozzle Holder	1
6	YAC-BS-PB-0008	O-Ring	2
7	BAC-BG-PB-0017	GF Hose Adapter	1
8	YAC-PF-PB-0206	Hose Barb	1
9	YAC-FN-PB-0132	Screw	2
10	YAC-PF-PB-0122	Hose Barb	1



BAC-BG-PB-0002



BAC-BG-PB-0003



BAC-BG-PB-0004



BAC-BG-PB-0005



BAC-BG-PB-0006



BAC-BG-PB-0007

Blast Nozzles

Item	Stock Code	Description	Qty
11	BAC-NZ-PB-0175	Blast Nozzle Godfrey 1/8" Tungsten	1
	BAC-NZ-PB-0179	Blast Nozzle Godfrey 3/16" Tungsten	1
	BAC-NZ-PB-0176	Blast Nozzle Godfrey 1/4" Tungsten	1
	BAC-NZ-PB-0227	Blast Nozzle Godfrey 5/16" Tungsten	1
	BAC-NZ-PB-0177	Blast Nozzle Godfrey 3/8" Tungsten	1
	BAC-NZ-PB-0178	Blast Nozzle Godfrey 1/2" Tungsten	1
	BAC-NZ-PB-0236	Blast Nozzle Godfrey 9/16" Tungsten	1
	BAC-NZ-PB-0153	Blast Nozzle 3/8" Steel/Tungsten	1

Air Tips

Item	Stock Code	Description	Qty
12	BAC-BG-PB-0011	1.6 mm (1/16") Air Jet	1
	BAC-BG-PB-0015	2.4 mm (3/32") Air Jet	1
	BAC-BG-PB-0012	3.2 mm (1/8") Air Jet	1
	BAC-BG-PB-0013	4.8 mm (3/16") Air Jet	1
	BAC-BG-PB-0014	6 mm (1/4") Air Jet	1



Omega Suction Blast Guns



Product Features

The PanBlast™ Omega Suction Blast Gun features a simplistic yet robust design to provide an economical retrofit solution for use in both manual and automated suction blast cabinets.

- ▶ Economical ceramic nozzles supplied standard.
- ▶ Available in a wide range of air tip/blast nozzle combinations.
- ▶ Optional ultra long life boron carbide nozzles.

Complementary Products



Filter Cartridge



Cabinet Window Cover



Blast Cabinets



Pow Air Vac



Delta SNH Auto Blast Gun



Delta GDF Auto Blast Gun



Delta SNH Manual Blast Gun



Delta GDF Manual Blast Gun

Common Applications

- ▶ Optional on PanBlast™ Blast Cabinets.
- ▶ OEM blast gun replacement and/or upgrade.

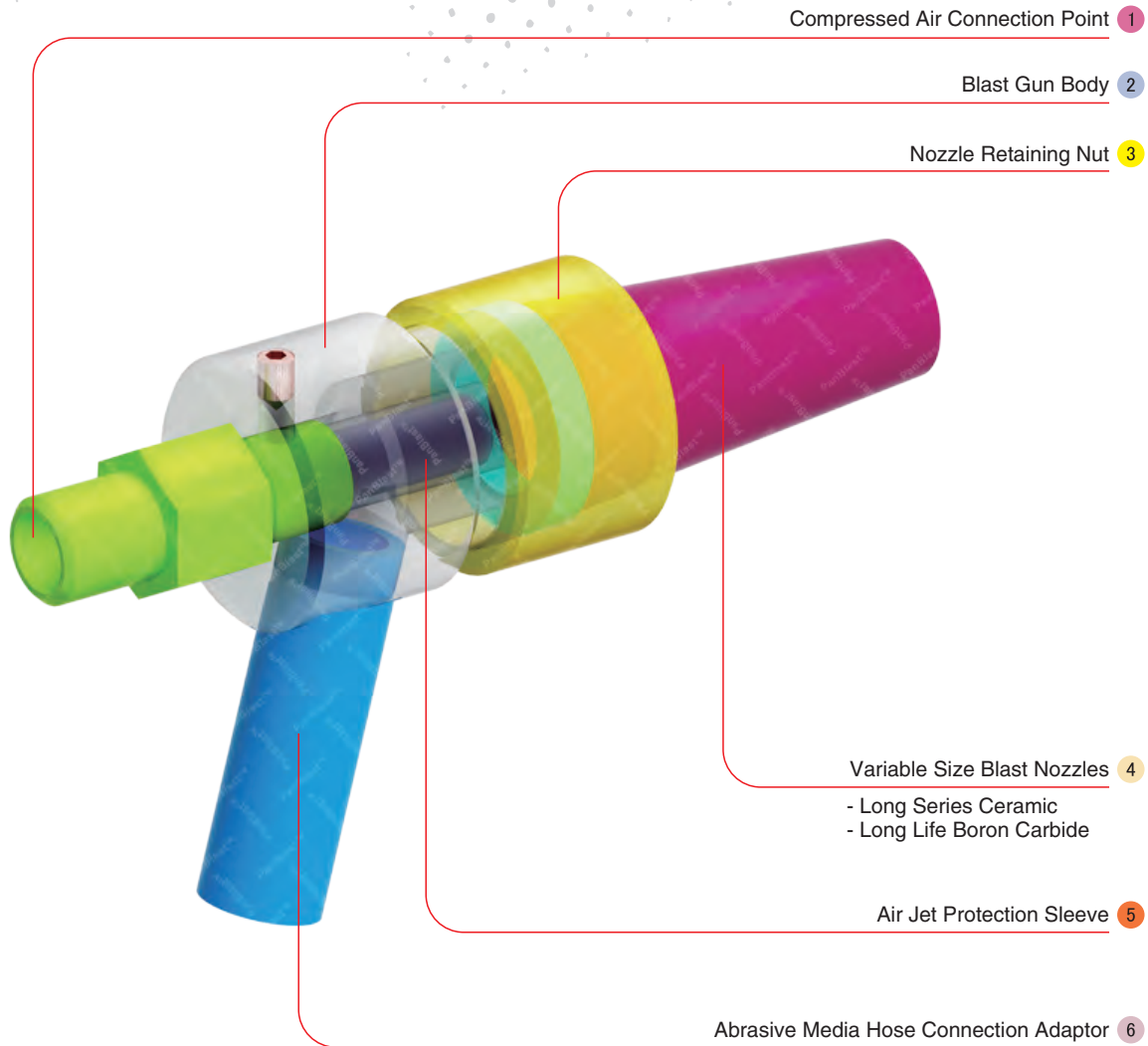

Component Highlights



1 Compressed Air Connection Point

3 Nozzle Retaining Nut

5 Air Jet Protection Sleeve

2 Blast Gun Body

4 Variable Size Blast Nozzles

6 Abrasive Media Hose Connection Adaptor

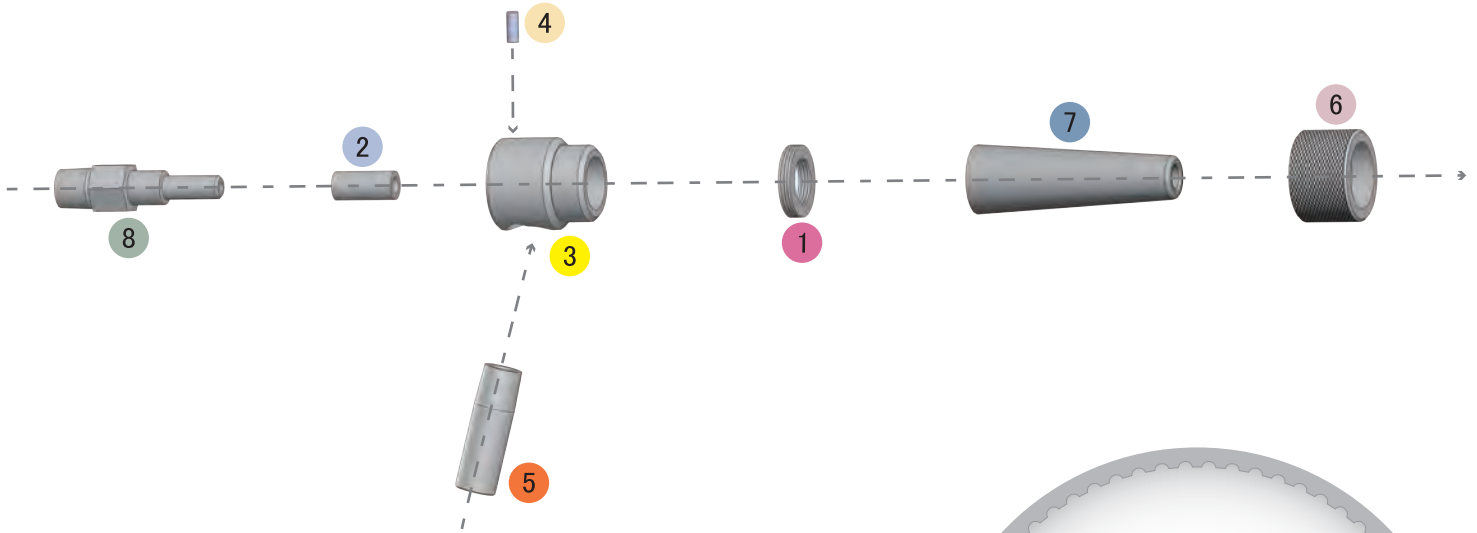
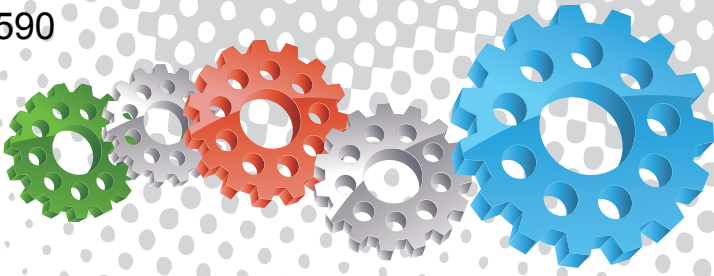

PanBlast™ Omega Suction Blast Guns

Stock Code	Description	Lock Nut	Blast Nozzle		Air Tip		Compressed Air Required
		Stock Code	Stock Code	Size	Stock Code	Size	
BAC-BG-0122-00	Omega Suction Blast Gun/6mm Boron Noz	YAV-BG-0124-00	BAC-NZ-PB-0264	6 mm (1/4")	YAC-BG-0123-00	3 mm (1/8")	36 m ³ /hr (21 cfm)
BAC-BG-0121-00	Omega Suction Blast Gun/9mm Boron Noz	YAV-BG-0124-00	BAC-NZ-PB-0265	9 mm (11/32")	YAC-BG-PB-0033	4.8 mm (3/16")	85 m ³ /hr (50 cfm)
BAC-BG-PB-0040	Omega Suction Blast Gun/6.4mm Cer Noz	YAC-BG-PB-0037	BAC-NZ-PB-0182	6.4 mm (1/4")	YAC-BG-0123-00	3 mm (1/8")	36 m ³ /hr (21 cfm)
BAC-BG-PB-0041	Omega Suction Blast Gun/7.9mm Cer Noz	YAC-BG-PB-0037	BAC-NZ-PB-0191	7.9 mm (5/16")	YAC-BG-PB-0033	4.8 mm (3/16")	85 m ³ /hr (50 cfm)
BAC-BG-PB-0042	Omega Suction Blast Gun/9.5mm Cer Noz	YAC-BG-PB-0037	BAC-NZ-PB-0197	9.5 mm (3/8")	YAC-BG-PB-0033	4.8 mm (3/16")	85 m ³ /hr (50 cfm)

Parts List

Item	Stock Code	Description	Qty
1	YAC-BG-PB-0036	Washer	1
2	YAC-BG-PB-0038	Gum Rubber Sleeve	1
3	YAC-BG-PB-0031	Gun Body	1
4	YAC-FN-PB-0145	Screw	1
5	YAC-BG-PB-0032	Media Inlet Tube	1



BAC-BG-0122-00



BAC-BG-0121-00

Lock Nuts

Item	Stock Code	Description	Qty
6	YAC-BG-0124-00	Nozzle Locknut	1
	YAC-BG-PB-0037	Nozzle Locknut	1

Blast Nozzles

Item	Stock Code	Description	Qty
7	BAC-NZ-PB-0264	SNH BSN Boron Blast Nozzle - 6 mm	1
	BAC-NZ-PB-0265	SNH BSN Boron Blast Nozzle - 9 mm	1
	BAC-NZ-PB-0182	Omega Ceramic Conical Nozzle - 6.4 mm	1
	BAC-NZ-PB-0191	Omega Ceramic Conical Nozzle - 7.9 mm	1
	BAC-NZ-PB-0197	Omega Ceramic Conical Nozzle - 9.5 mm	1



BAC-BG-PB-0040



BAC-BG-PB-0041

Air Tips

Item	Stock Code	Description	Qty
8	YAC-BG-0123-00	3 mm Rubberized Air Jet	1
	YAC-BG-PB-0033	4.8 mm Rubberized Air Jet	1



BAC-BG-PB-0042

Архангельск (8182)63-90-72
Астана (7172)727-132
Астрахань (8512)99-46-04
Барнаул (3852)73-04-60
Белгород (4722)40-23-64
Брянск (4832)59-03-52
Владивосток (423)249-28-31
Волгоград (844)278-03-48
Вологда (8172)26-41-59
Воронеж (473)204-51-73
Екатеринбург (343)384-55-89
Иваново (4932)77-34-06

Ижевск (3412)26-03-58
Иркутск (395)279-98-46
Казань (843)206-01-48
Калининград (4012)72-03-81
Калуга (4842)92-23-67
Кемерово (3842)65-04-62
Киров (8332)68-02-04
Краснодар (861)203-40-90
Красноярск (391)204-63-61
Курск (4712)77-13-04
Липецк (4742)52-20-81

Киргизия (996)312-96-26-47

Магнитогорск (3519)55-03-13
Москва (495)268-04-70
Мурманск (8152)59-64-93
Набережные Челны (8552)20-53-41
Нижний Новгород (831)429-08-12
Новокузнецк (3843)20-46-81
Новосибирск (383)227-86-73
Омск (3812)21-46-40
Орел (4862)44-53-42
Оренбург (3532)37-68-04
Пенза (8412)22-31-16

Россия (495)268-04-70

Пермь (342)205-81-47
Ростов-на-Дону (863)308-18-15
Рязань (4912)46-61-64
Самара (846)206-03-16
Санкт-Петербург (812)309-46-40
Саратов (845)249-38-78
Севастополь (8692)22-31-93
Симферополь (3652)67-13-56
Смоленск (4812)29-41-54
Сочи (862)225-72-31
Ставрополь (8652)20-65-13

Казахстан (772)734-952-31

Сургут (3462)77-98-35
Тверь (4822)63-31-35
Томск (3822)98-41-53
Тула (4872)74-02-29
Тюмень (3452)66-21-18
Ульяновск (8422)24-23-59
Уфа (347)229-48-12
Хабаровск (4212)92-98-04
Челябинск (351)202-03-61
Череповец (8202)49-02-64
Ярославль (4852)69-52-93

www.panblast.nt-rt.ru | | pav@nt-rt.ru