

Архангельск (8182)63-90-72
Астана (7172)727-132
Астрахань (8512)99-46-04
Барнаул (3852)73-04-60
Белгород (4722)40-23-64
Брянск (4832)59-03-52
Владивосток (423)249-28-31
Волгоград (844)278-03-48
Вологда (8172)26-41-59
Воронеж (473)204-51-73
Екатеринбург (343)384-55-89
Иваново (4932)77-34-06

Ижевск (3412)26-03-58
Иркутск (395)279-98-46
Казань (843)206-01-48
Калининград (4012)72-03-81
Калуга (4842)92-23-67
Кемерово (3842)65-04-62
Киров (8332)68-02-04
Краснодар (861)203-40-90
Красноярск (391)204-63-61
Курск (4712)77-13-04
Липецк (4742)52-20-81

Киргизия (996)312-96-26-47

Магнитогорск (3519)55-03-13
Москва (495)268-04-70
Мурманск (8152)59-64-93
Набережные Челны (8552)20-53-41
Нижний Новгород (831)429-08-12
Новокузнецк (3843)20-46-81
Новосибирск (383)227-86-73
Омск (3812)21-46-40
Орел (4862)44-53-42
Оренбург (3532)37-68-04
Пенза (8412)22-31-16

Россия (495)268-04-70

Пермь (342)205-81-47
Ростов-на-Дону (863)308-18-15
Рязань (4912)46-61-64
Самара (846)206-03-16
Санкт-Петербург (812)309-46-40
Саратов (845)249-38-78
Севастополь (8692)22-31-93
Симферополь (3652)67-13-56
Смоленск (4812)29-41-54
Сочи (862)225-72-31
Ставрополь (8652)20-65-13

Казахстан (772)734-952-31

Сургут (3462)77-98-35
Тверь (4822)63-31-35
Томск (3822)98-41-53
Тула (4872)74-02-29
Тюмень (3452)66-21-18
Ульяновск (8422)24-23-59
Уфа (347)229-48-12
Хабаровск (4212)92-98-04
Челябинск (351)202-03-61
Череповец (8202)49-02-64
Ярославль (4852)69-52-93

www.panblast.nt-rt.ru | | pav@nt-rt.ru

**Технические характеристики на
запчасти для защитного снаряжения,
картриджи для фильтров,
запчасти для ударного колеса,
аксессуары для сопел
компании PanBlast**



Aurora Helmet Blast Light Mounting Kit



Product Features

The PanBlast™ Aurora Helmet Mounted Blast Light is designed to provide cool, bright, efficient lighting to most blast helmets currently in the market.

- ▶ Industrial quality hook and loop strip mounting.
- ▶ Steel strap and bracket.
- ▶ Fully adjustable for correct targeting.
- ▶ 3.7 V rechargeable lithium ion battery included.
- ▶ 20+ hours of operation at 1000-1300 lx per charge.
- ▶ Maintenance-free LED.
- ▶ No heat generated.
- ▶ Replaceable glass lens.
- ▶ Waist belt mounted battery pouch.
- ▶ Heavy Duty bayonet cable connectors.
- ▶ Battery life up to 500 cycles.
- ▶ Chargers available to suit various power supplies.
- ▶ Blast hose mounting kit also available.

Common Applications

- ▶ Blast room and on site operations with high dust levels.
- ▶ Abrasive blasting in confined spaces.
- ▶ Nighttime blasting operations.

Complementary Products



Titan II SAR



Cosmo SAR



Galaxy Blast Helmet



Spartan Blast Helmet



PBF II-1 Airline Filter



Air Cooling Controller



Leather Blasting Suit



VisiFlo Premium Airline Filter

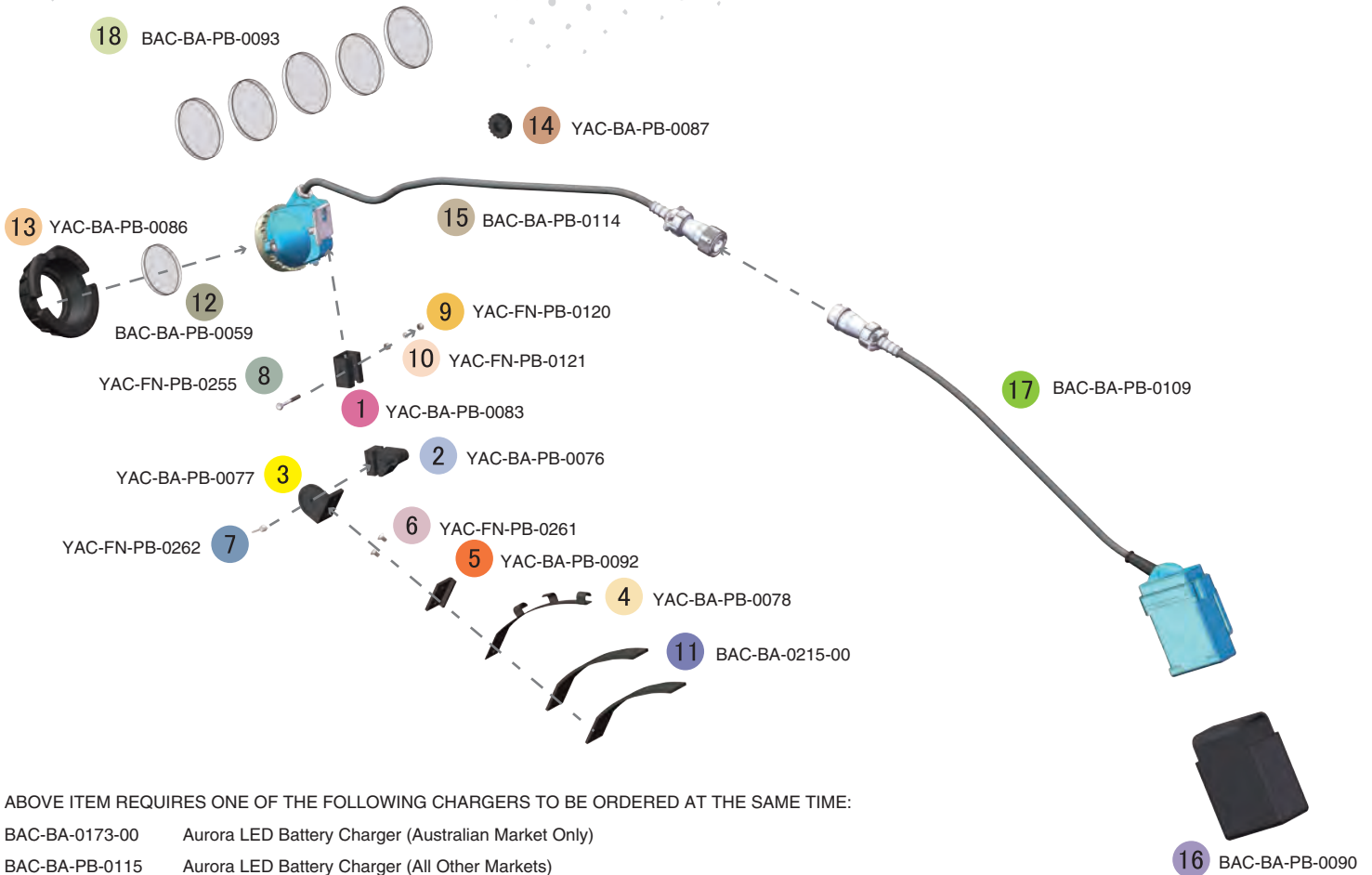
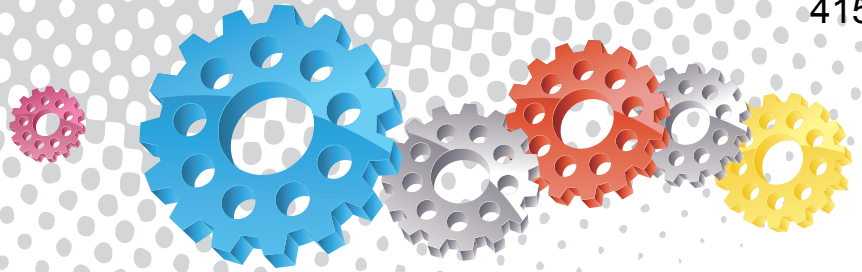

All data and information subject to change without prior notice. Brochure reference CAT-1604-01-00

Assembly



Stock Code	Description	Weight
BAC-BA-0075-06	Aurora Helmet Blast Light Mounting Kit	2.3 kg (5.07 lbs)

Parts List

Description	Qty	Description	Qty	Description	Qty
1 Light Holder	1	7 Wing Nut	1	13 Glass Holder	1
2 Adjustable Helmet Mounting	1	8 Hex Head Bolt	1	14 Switch Knob	1
3 Holder Base	1	9 M4 Nut	2	15 Aurora LED 3.7 V Lamp Kit	1
4 Base	1	10 Spring Washer	1	16 Aurora LED Blast Light Battery Pouch	1
5 Base Top Plate	1	11 Aurora LED Blast Helmet Fastener Kit	1	17 Aurora LED Battery Pack	1
6 Screw	2	12 Aurora LED Glass	1	18 Aurora LED Lens Kit (Excludes from BAC-BA-0075-06)	12 x 5



Light Weight Blast Suits



Product Features

Blast suits protect the operator from the impact of rebounding abrasives. The light weight blast suit is a cost-effective alternative to a standard suit for intermittent or short-term blasting, and for non-blast personnel working at the blast site.

- ▶ Durable, lightweight blast suit construction for long life.
- ▶ Front made of sturdy nylon (similar to hood capes).
- ▶ Rear is made of 100% cotton for breathability.
- ▶ Heavy-duty zipper.
- ▶ Velcro overlay panel protects zipper.
- ▶ Heavy duty velcro wrist and ankle closures.
- ▶ Adjustable velcro straps on wrist and ankles.

Common Applications

- ▶ Economical protection for blast site operators from ricocheting abrasives.

Complementary Products



Cosmo SAR



Titan II SAR



Galaxy Blast Helmet



Spartan Blast Helmet



PBF II-1 Airline Filter



Leather Blasting Suit



Air Cooling Controller



Climate Controller

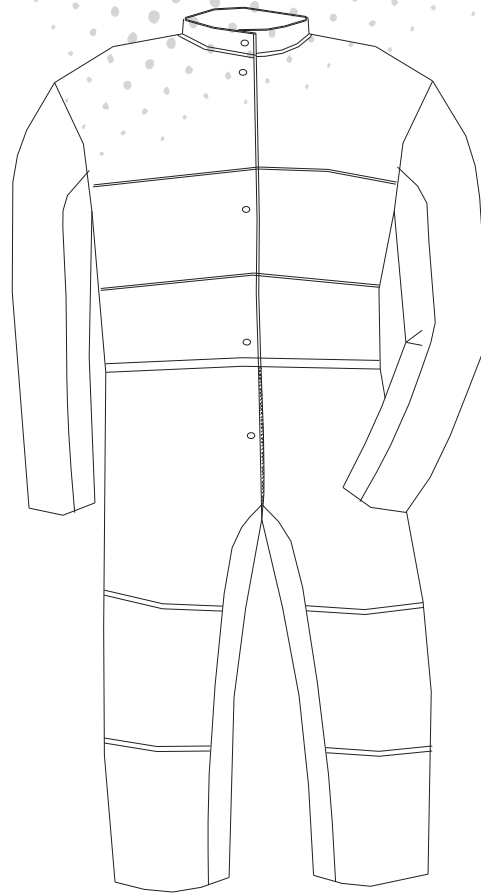

Materials

Suit Material	Light weight nylon fabric/heavy drill cotton fabric
Weight/Thickness	Light weight nylon fabric with 300 gsm heavy drill cotton fabric
Stitching	Single/double stitch, 8 stitches to an inch
Thread	Polyester
Color	Blue/white
Packaging	Polybag
Complies With The Following Regulations	AZO Free 100% cotton

Stock Code	Description
BAC-OC-0007-00	Light Weight Blast Suit – Small Size
BAC-OC-0008-00	Light Weight Blast Suit – Medium Size
BAC-OC-0009-00	Light Weight Blast Suit – Large Size
BAC-OC-0010-00	Light Weight Blast Suit – XL Size
BAC-OC-0011-00	Light Weight Blast Suit – XXL Size
BAC-OC-0012-00	Light Weight Blast Suit – XXXL Size



Blast Suits and Gloves



Product Features

PanBlast™ Blast Suits and Leather Blast Gloves provide durable and lightweight protection for blasting operators in applications requiring the use of metallic abrasives such as steel grit and chilled iron grit.

- ▶ Leather fronts offer solid protection.
- ▶ Cotton back reduces weight and provides ventilation.
- ▶ Four (4) sizes available from Small (S) to Extra Large (XL).

Common Applications

- ▶ Protection of blast hose operators from rebounding abrasives and debris in blast room, yard and on-site operations.

Complementary Products



Cosmo SAR



Titan II SAR



Galaxy Blast Helmet



Spartan Blast Helmet



PBF II-1 Airline Filter



VisiFlo Premium Airline Filter



Air Cooling Controller



Climate Controller

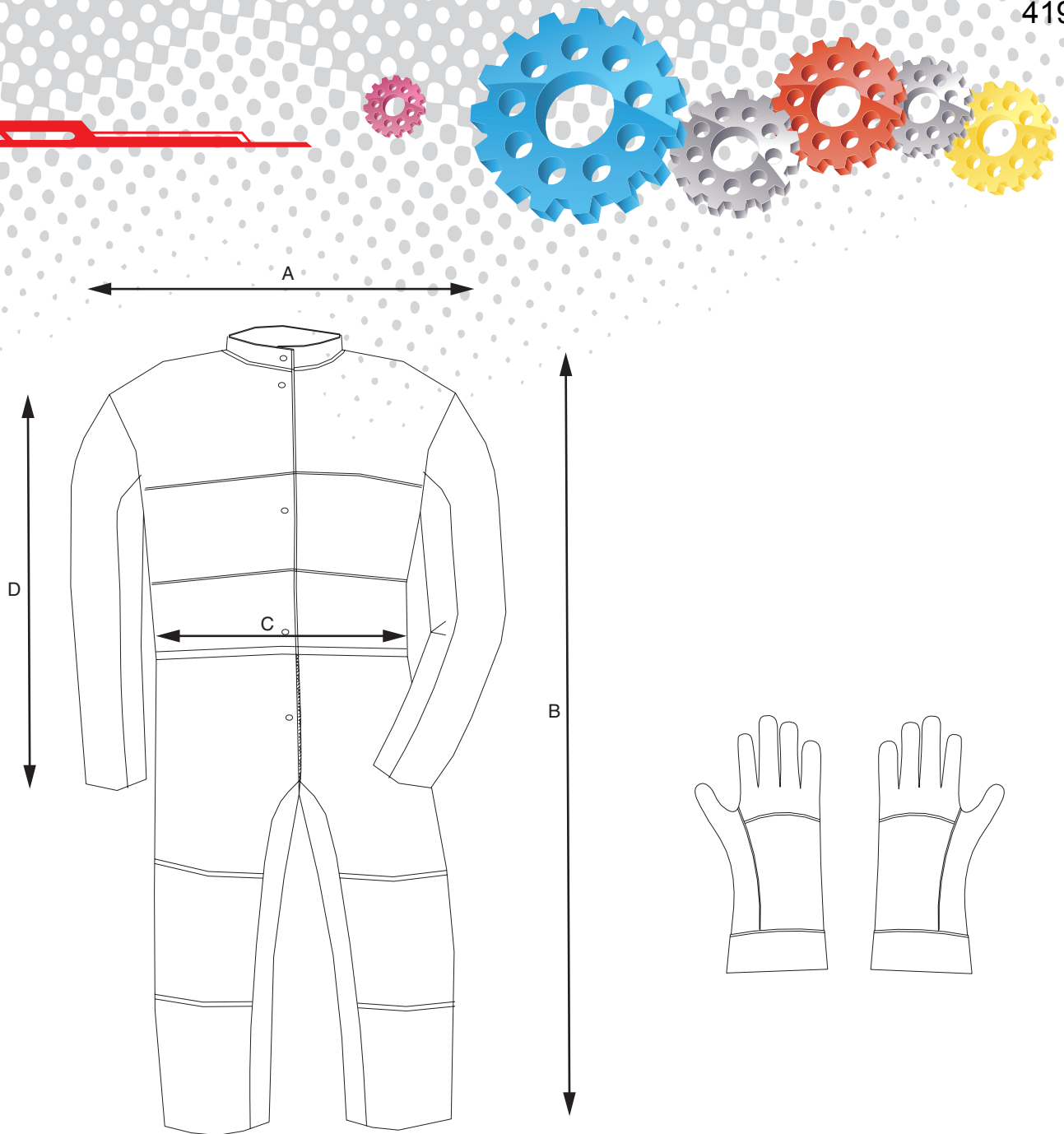

Blast Suits Dimensions

Size	A	B	C	D
Small	560 mm	1500 mm	450 mm	600 mm
Medium	580 mm	1550 mm	540 mm	620 mm
Large	600 mm	1570 mm	550 mm	630 mm
Extra Large	620 mm	1600 mm	630 mm	630 mm

Blast Suits and Gloves

Stock Code	Description	Packing Dimensions	Weight
BAC-OC-PB-0003	Blasting Suit - Small Size	58 cm × 42 cm × 4 cm	2.55 kg (5.61 lbs)
BAC-OC-PB-0004	Blasting Suit - Medium Size	58 cm × 42 cm × 5 cm	2.55 kg (5.61 lbs)
BAC-OC-PB-0005	Blasting Suit - Large Size	58 cm × 42 cm × 5 cm	3.00 kg (6.60 lbs)
BAC-OC-PB-0006	Blasting Suit - Extra Large Size	58 cm × 42 cm × 5 cm	3.00 kg (6.60 lbs)
BAC-OC-PB-0001	Blasting Gloves - Gauntlet Leather	34 cm × 15 cm × 1.5 cm	0.25 kg (0.551 bs)



Blast Wheel Parts

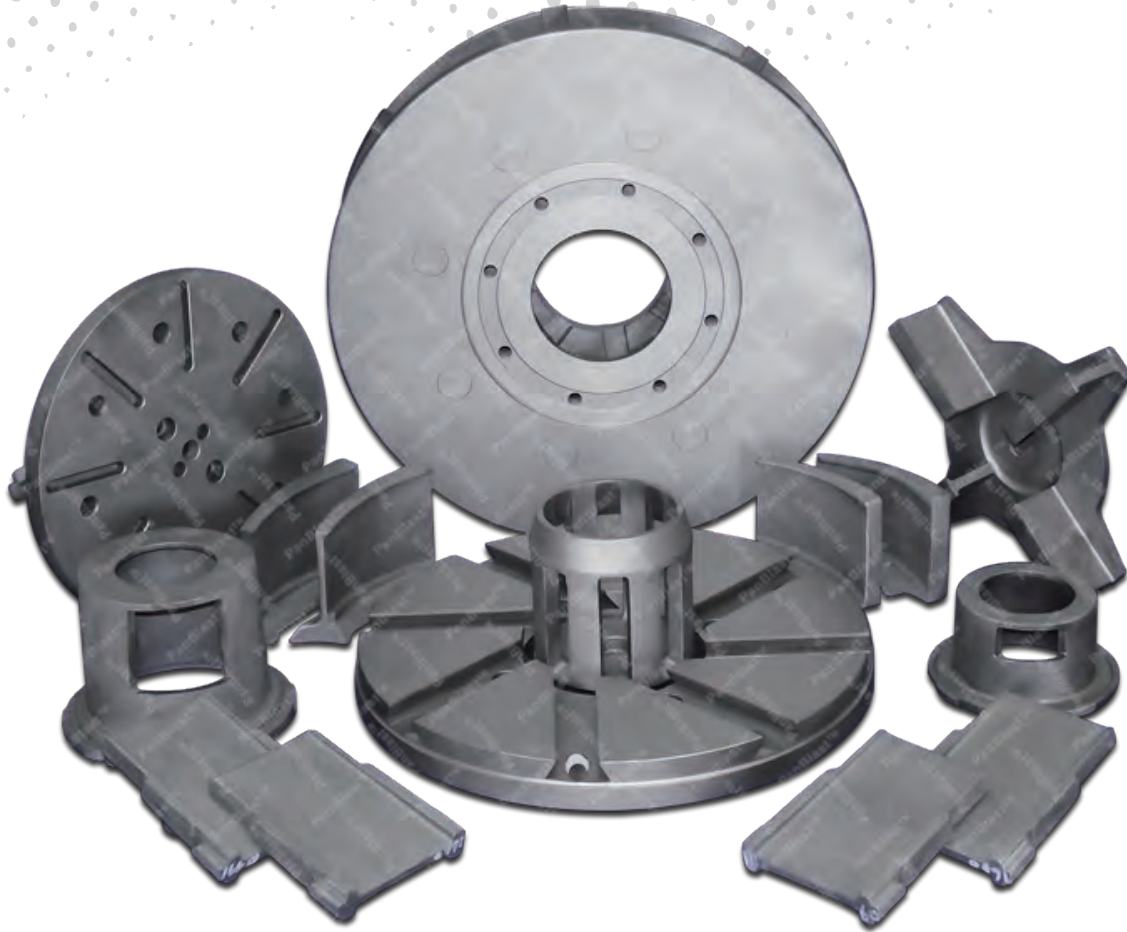

Product Features

PanBlast™ Blast Wheel Parts are manufactured using chrome molybdenum alloy via an investment casting process to achieve tight tolerances, excellent surface finish and enhanced durability when compared to conventional sand casted parts. The parts are then heat treated to achieve surface hardnesses of up to 65 HRc.

- ▶ Manufactured according to Panblast or OEM drawings.
- ▶ Manufactured according to supplied sample parts.
- ▶ Plug and play retrofit of parts to existing equipment.
- ▶ Superior lost wax investment casting manufacturing process.
- ▶ High quality, low porosity castings with excellent surface finish.
- ▶ Extended parts durability from heat treated alloy.

Common Applications

- ▶ New airless blast machine installations.
- ▶ OEM airless blast machine parts replacement.
- ▶ OEM airless blast machine performance improvement.

Complementary Products



Pressure Blast Pots



Pow Air Vac



Airless Spray Pumps



Dust Collector Silencer



Filter Cartridge



Painting Hood



Dust Collector



Respirator Airline Hoses

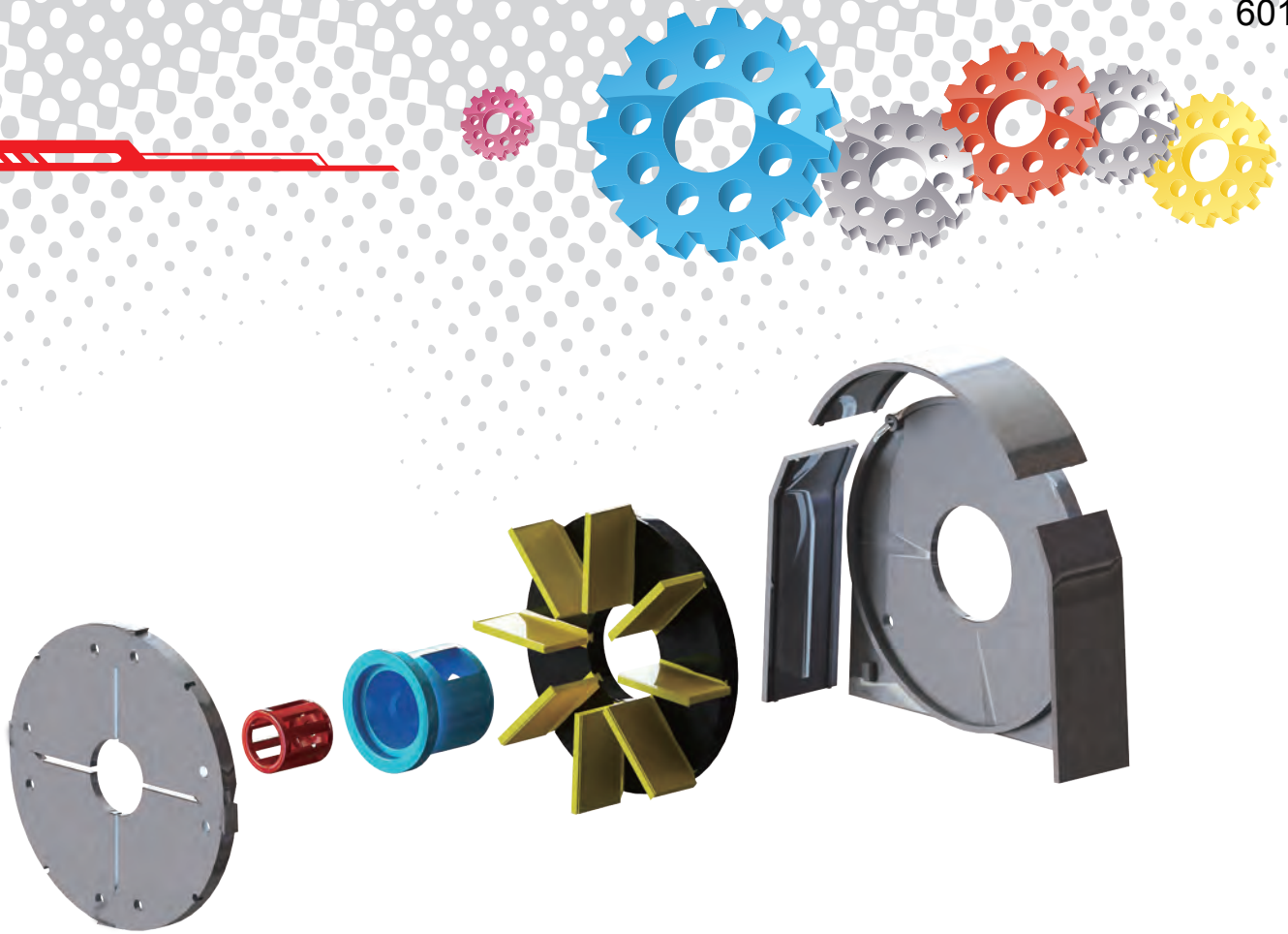

Stock Code	Description	Stock Code	Description
BEQ-FV-0012-00	PN 18-4 CCW Wheel Vanes	BEQ-FI-PB-0001	BH Wheel Impeller
BEQ-FV-0026-00	PN 18-4 CW Wheel Vanes	BEQ-FI-PB-0002	LE Wheel Impeller
BEQ-FV-0014-00	TS T-37 Vanes	BEQ-FI-PB-0003	OG Wheel Impeller
BEQ-FV-0015-00	Q034-330/80 Blade	BEQ-FI-PB-0004	CB Wheel Impeller
BEQ-FV-PB-0006	OG Wheel Vanes	BEQ-FI-PB-0005	SK MK1 Wheel Impeller
BEQ-FV-PB-0007	CB Wheel Vanes	BEQ-FI-PB-0006	PN RK180/RI195 CW Impeller
BEQ-FV-PB-0008	SK 15" Bi-Rotational Vanes	BEQ-FI-PB-0007	PN 180-4RK CW Wheel Impeller
BEQ-FV-PB-0009	SK 13" Bi-Rotational Vanes	BEQ-FI-PB-0008	SK 13"/15" Wheel Impeller
BEQ-FV-SK-IWP124	SK 15" CW Wheel Vanes	BEQ-FI-PB-0009	SK 13" Bi-Rotation Impeller
BEQ-FV-SK-IWP141	SK 19.5" CW Extended Vanes	BEQ-FI-SK-IWP769	SK ST1 Wheel Impeller
BEQ-FV-SK-IWP245	SK 15" CW Extended Vanes	BEQ-FC-0008-00	OG Wheel Control Cage
BEQ-FV-SK-IWP246	SK 15" CCW Extended Vanes	BEQ-FC-0016-00	Q034 Wheel Control Cage
BEQ-FI-0003-00	OG Wheel Impeller	BEQ-FC-PB-0002	LE Wheel Control Cage
BEQ-FI-0007-00	PN 18-4 CW Wheel Impeller	BEQ-FC-SK-IWP134	SK 15" Control Cage
BEQ-FI-0015-00	PN 18-4 CCW Wheel Impeller	BEQ-FC-SK-IWP186	SK 13"/15" Control Cage
BEQ-FI-0016-00	Q034 Wheel Impeller	BEQ-FC-SK-IWP770	SK ST1 Wheel Control Cage



Wet Head Assembly



Product Features

The PanBlast™ Wet Head Assembly provides a water envelope around the blasting air and abrasive stream, in order to reduce the dust levels generated by the blasting process. Up to 80% of the dust produced may be suppressed by this water envelope.

- ▶ Lightweight, durable nylon construction.
- ▶ Quick attachment via 3 tensioning screws.
- ▶ Operates at standard water line pressures.
- ▶ Connecting hose with flow regulation valve included.

Common Applications

- ▶ Abrasive blasting in populated areas.
- ▶ Masonry and concrete blast cleaning.

Complementary Products



ATN Blast Nozzles



ATV Blast Nozzles



Nylon Nozzle Holders



Aluminum Nozzle Holders



Blast Hoses



Pressure Blast Pots



AirFlo Pneumatic Handle



QuikStop IIS Pneumatic Handle

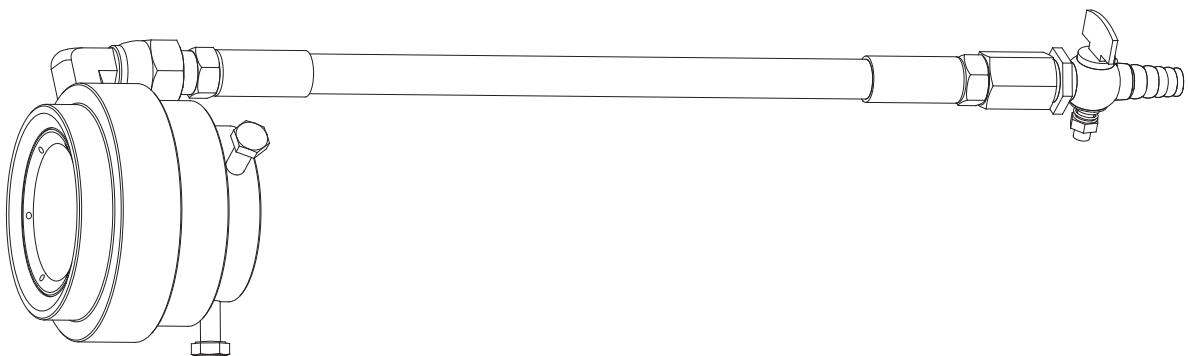
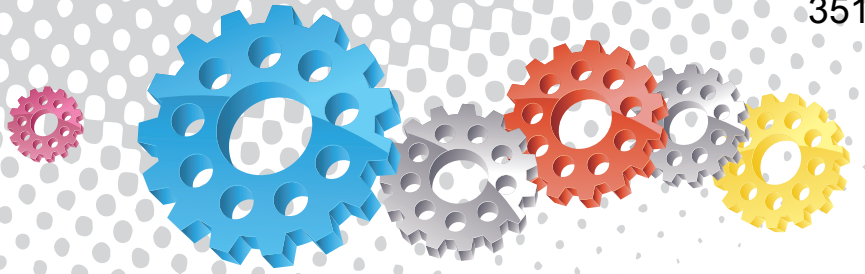

Stock Code	Description	Weight
BAC-NZ-PB-0340	Wet Head Assembly	0.36 kg (0.79 lbs)



KB50 Wet Blast Assembly

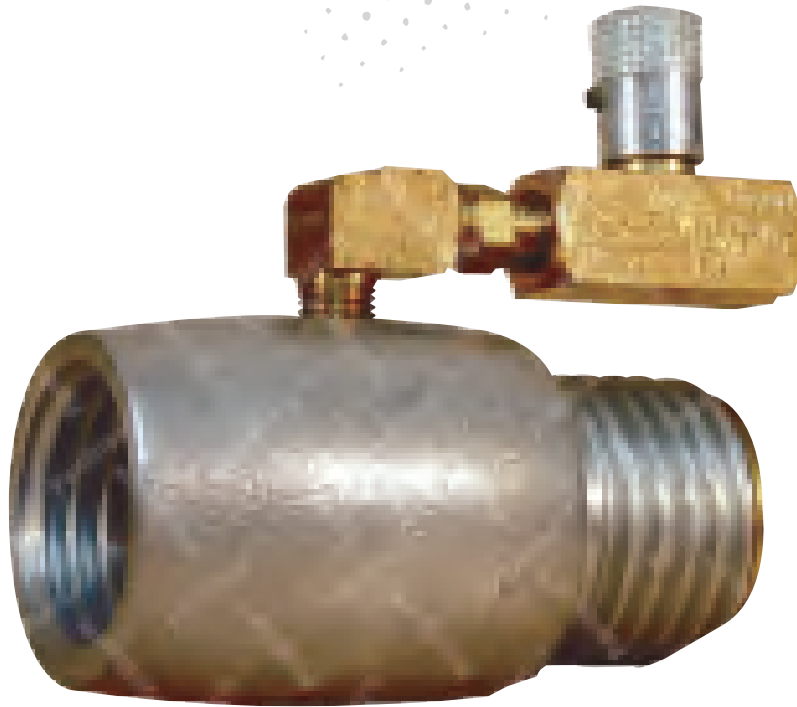

Product Features

The KB50 Wet Blast Assembly is utilized to inject a water supply directly into the blasting air stream just prior to entering the nozzle. It is supplied with two 50 mm (2") threads; one internal for attachment to the blast nozzle, and one external for attachment to the nozzle holder.

- ▶ Needle-valve for adjustment of water supply.
- ▶ Operates at standard water line pressures.
- ▶ Internal wear liner protection.

Common Applications

- ▶ Abrasive blasting in populated areas.
- ▶ Masonry and concrete blast cleaning.

Complementary Products



ATN Blast Nozzles



ATV Blast Nozzles



Nylon Nozzle Holders



Aluminum Nozzle Holders



Blast Hoses



Pressure Blast Pots



AirFlo Pneumatic Handle



QuikStop IIS Pneumatic Handle

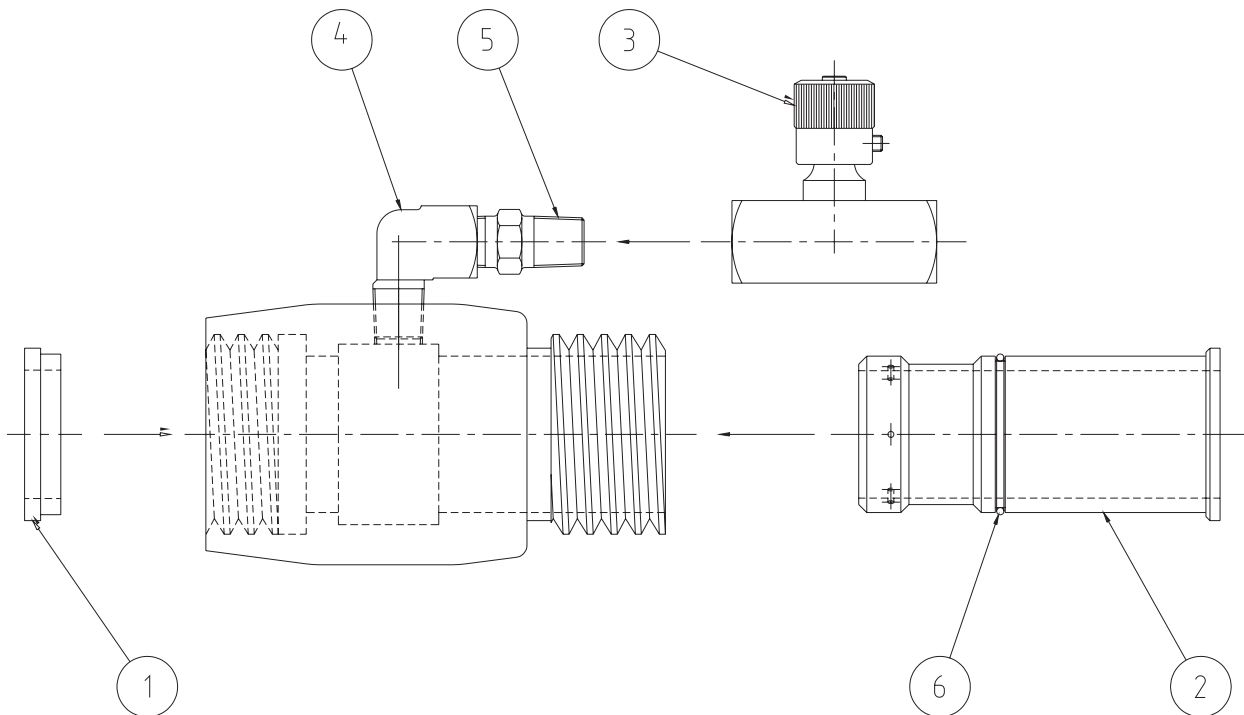

Stock Code	Description	Weight
BAC-NZ-CL-05598	KB50 Wet Blast Assembly	0.56 kg (1.23 lbs)

Parts List

	Stock Code	Description	Qty
1	BAC-NZ-PB-0031	RNW-32 Nozzle Washer	1
2	BAC-NZ-CL-05535	Injector Ring P/N.05535	1
3	BAC-NZ-CL-05528	Valve Wet Blast KB50 Needle	1
4	YAC-PF-0428-00	Elbow	1
5	YAC-PF-0429-00	Nipple - 1/4"	1
6	YAC-NZ-CL-05516	O-Ring	1



Hypodermic Needle Gauge



Product Features

The PanBlast™ Hypodermic Needle Gauge is a practical and economical tool for verifying blast pressure where it matters most – at the blast nozzle. It is particularly relevant for pressure-critical applications, blasting systems with extended hose lengths, and for verifying blast pressure after some nozzle wear.

- ▶ Full range, base entry pressure dial indicator.
- ▶ Fine hypodermic needle for clean blast hose penetration.
- ▶ No blast hose leaks after hypodermic needle removal.

Common Applications

- ▶ Actual pressure verification at the blast nozzle.
- ▶ To assist with blast equipment setup and quality control.
- ▶ Blast pressure verification after some nozzle wear.

Complementary Products



Blast Hoses



AIN Blast Nozzles



ATV Blast Nozzles



ATN Blast Nozzles



ATN-S Blast Nozzles



SideWinder Blast Nozzles



Pressure Blast Pots



Cosmo SAR

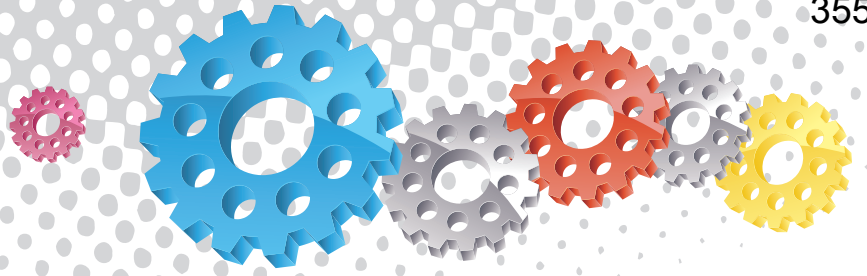

Stock Code	Description	Weight
BAC-BA-0231-01	Hypodermic Needle Gauge	0.18 kg (0.39 lbs)
BAC-BA-0234-00	Hypodermic Needles Kit (20/PKT)	



Filter Cartridges



Product Features

PanBlast™ Filter Cartridges are available in several standard sizes to suit standard dust collectors featuring reverse air pulse jet cleaning. Each filter cartridge is made from durable pleated cellulose/polyester media with rubber gasket sealing.

- ▶ Durable double pleated cellulose/polyester media.
- ▶ MERV13 Filtration efficiency.
- ▶ Either bands or metal cages to keep fabric media intact during pulse cleaning.
- ▶ Rubber gasket sealing for open ends.
- ▶ Custom sizes and design upon request.

Common Applications

- ▶ On site industrial and commercial blasting.
- ▶ Blast and painting contractor yard work.
- ▶ Blast room applications.
- ▶ In situ blasting in shipyards and slipways.

Complementary Products



Delta GDF Manual Blast Gun



Delta SNH Auto Blast Gun



Dust Collector



AER215 Nuovo Vacuum Blaster

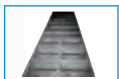

Waffle Floor



UltraFlo Recycling System



Blast Cabinets



ProFlo Recycling System



BAC-DF-PB-0004



BAC-DF-PB-0002



BAC-DF-PB-0016



BAC-DF-PB-0005



BAC-DF-PB-0008

PanBlast™ Filter Cartridges

Stock Code	Description	Specification
BAC-DF-PB-0004	Filter Cartridge - Size 1 (Open/Close)	255 mm OD x 155 mm ID x 510 mm L
BAC-DF-PB-0002	Filter Cartridge - Size 2 (Open/Close)	320 mm OD x 216 mm ID x 660 mm L
BAC-DF-PB-0016	Filter Cartridge - Size 2 (Open/Open)	320 mm OD x 216 mm ID x 660 mm L
BAC-DF-PB-0005	Filter Cartridge - Size 3 (Open/Close)	352 mm OD x 238 mm ID x 880 mm L
BAC-DF-PB-0007	Filter Cartridge - Size 4 (Open/Open)	240 mm OD x 175 mm ID x 152 mm L
BAC-DF-PB-0008	Filter Cartridge - Size 5 (Open/Open)	145 mm OD x 60 mm ID x 202 mm L
BAC-DF-0024-00	Filter Cartridge - Size 6 (Open/Close)	324 mm OD x 213 mm ID x 1000 mm L
BAC-DF-0025-00	Filter Cartridge - Size 7 (Open/Open)	352 mm OD x 241 mm ID x 660 mm L
BAC-DF-0026-00	Filter Cartridge - Size 7 (Open/Close)	352 mm OD x 241 mm ID x 660 mm L

Архангельск (8182)63-90-72
Астана (7172)727-132
Астрахань (8512)99-46-04
Барнаул (3852)73-04-60
Белгород (4722)40-23-64
Брянск (4832)59-03-52
Владивосток (423)249-28-31
Волгоград (844)278-03-48
Вологда (8172)26-41-59
Воронеж (473)204-51-73
Екатеринбург (343)384-55-89
Иваново (4932)77-34-06

Ижевск (3412)26-03-58
Иркутск (395)279-98-46
Казань (843)206-01-48
Калининград (4012)72-03-81
Калуга (4842)92-23-67
Кемерово (3842)65-04-62
Киров (8332)68-02-04
Краснодар (861)203-40-90
Красноярск (391)204-63-61
Курск (4712)77-13-04
Липецк (4742)52-20-81

Киргизия (996)312-96-26-47

Магнитогорск (3519)55-03-13
Москва (495)268-04-70
Мурманск (8152)59-64-93
Набережные Челны (8552)20-53-41
Нижний Новгород (831)429-08-12
Новокузнецк (3843)20-46-81
Новосибирск (383)227-86-73
Омск (3812)21-46-40
Орел (4862)44-53-42
Оренбург (3532)37-68-04
Пенза (8412)22-31-16

Россия (495)268-04-70

Пермь (342)205-81-47
Ростов-на-Дону (863)308-18-15
Рязань (4912)46-61-64
Самара (846)206-03-16
Санкт-Петербург (812)309-46-40
Саратов (845)249-38-78
Севастополь (8692)22-31-93
Симферополь (3652)67-13-56
Смоленск (4812)29-41-54
Сочи (862)225-72-31
Ставрополь (8652)20-65-13

Казахстан (772)734-952-31

Сургут (3462)77-98-35
Тверь (4822)63-31-35
Томск (3822)98-41-53
Тула (4872)74-02-29
Тюмень (3452)66-21-18
Ульяновск (8422)24-23-59
Уфа (347)229-48-12
Хабаровск (4212)92-98-04
Челябинск (351)202-03-61
Череповец (8202)49-02-64
Ярославль (4852)69-52-93

www.panblast.nt-rt.ru | | pav@nt-rt.ru